

Features

- 2500 UT Unitwall® is a pre-glazed unitized curtain wall
- 2-1/2" (63.5) sightline. System depths of:
 - 7-1/2" (190.5) captured and 6-1/2" (165.1) 4-side SSG with 1" (25.4) infill
 - 8-1/4" (209.6) captured and 7-1/4" (184.2) 4-side SSG with 1-3/4" (44.5) infill
- Patented polyamide thermal break
- Screw spline shop assembly
- Shop glazed infill options:
 - 1" (25.4) and 1-3/4" (44.5) insulating vision
 - 1" (25.4) and 1-3/4" (44.5) insulating spandrel
- Three system types available:
 - Captured
 - 4-sided SSG (all glass exterior look)
 - 2-sided Vertical SSG (Captured-Horizontal)
- No exterior applied joint seals. Can be fully installed from inside, saving installation costs
- Available spandrel back panning with enhanced pressure equalized venting/weeping options
- Exterior re-glazing capability
- 90° and 135° inside and outside corners
- Top of slab fully adjustable anchoring $\pm 1"$ in & out, up & down and left & right
- Comprehensively tested to North American Standards, including seismic, thermal, and acoustical standards
- Two color option
- Permanodic® anodized finishes option
- Painted finishes in standard and custom choices

Optional Features

- Steel reinforcing available
- Accepts GLASSvent® UT windows with captured system type
- Profit\$Maker® Plus die sets available

Product Applications

- Suitable for new construction or remodel
- Ideal for mid-rise and high-rise applications

For specific product applications,
consult your Kawneer representative.

Laws and building and safety codes governing the design and use of Kawneer products, such as glazed entrance, window, and curtain wall products, vary widely. Kawneer does not control the selection of product configurations, operating hardware, or glazing materials, and assumes no responsibility therefor.

Kawneer reserves the right to change configuration without prior notice when deemed necessary for product improvement.
© 2015, Kawneer Company, Inc.

Architects – Most extrusions illustrated in this catalog are standard products for Kawneer. These concepts have been expanded and modified to afford you design freedom. Some miscellaneous details are non-standard and are intended to demonstrate how the system can be modified to expand design flexibility. Please contact your Kawneer representative for further assistance.

PICTORIAL VIEWS.....4, 5

1" INFILL DETAILS

CAPTURED SYSTEM 6

4-SIDED SSG SYSTEM..... 7

VERTICAL SSG SYSTEM..... 8

CORNERS 9, 10

GLASSvent® UT WINDOWS 11

1-3/4" INFILL DETAILS

CAPTURED SYSTEM 12

4-SIDED SSG SYSTEM..... 13

VERTICAL SSG SYSTEM..... 14

CORNERS 15, 16

GLASSvent® UT WINDOWS 17

ANCHORING 18

WIND LOAD CHARTS.....19-22

DEADLOAD CHARTS 23, 24

THERMAL CHARTS25-40

Metric (SI) conversion figures are included throughout these details for reference. Numbers in parentheses () are millimeters unless otherwise noted.

The following metric (SI) units are found in these details:

- m – meter
- cm – centimeter
- mm – millimeter
- s – second
- Pa – pascal
- MPa – megapascal

Laws and building and safety codes governing the design and use of Kawneer products, such as glazed entrance, window, and curtain wall products, vary widely. Kawneer does not control the selection of product configurations, operating hardware, or glazing materials, and assumes no responsibility therefor.

Kawneer reserves the right to change configuration without prior notice when deemed necessary for product improvement.
© 2015, Kawneer Company, Inc.

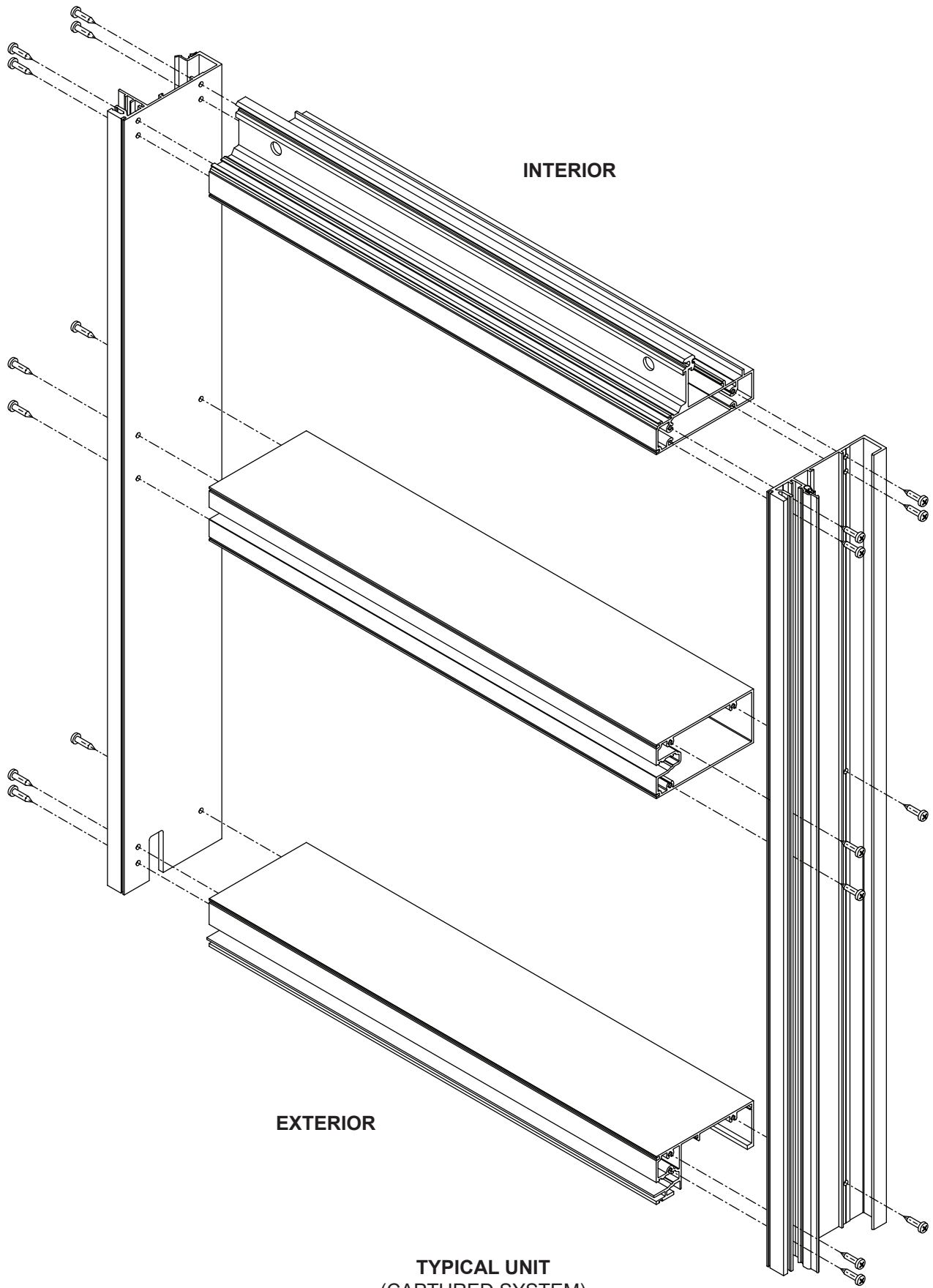

Laws and building and safety codes governing the design and use of Kawneer products, such as glazed entrance, window, and curtain wall products, vary widely. Kawneer does not control the selection of product configurations, operating hardware, or glazing materials, and assumes no responsibility therefor.

Kawneer reserves the right to change configuration without prior notice when deemed necessary for product improvement.
© 2015, Kawneer Company, Inc.

Laws and building and safety codes governing the design and use of Kawneer products, such as glazed entrance, window, and curtain wall products, vary widely. Kawneer does not control the selection of product configurations, operating hardware, or glazing materials, and assumes no responsibility therefor.

Kawneer reserves the right to change configuration without prior notice when deemed necessary for product improvement.
© 2015, Kawneer Company, Inc.

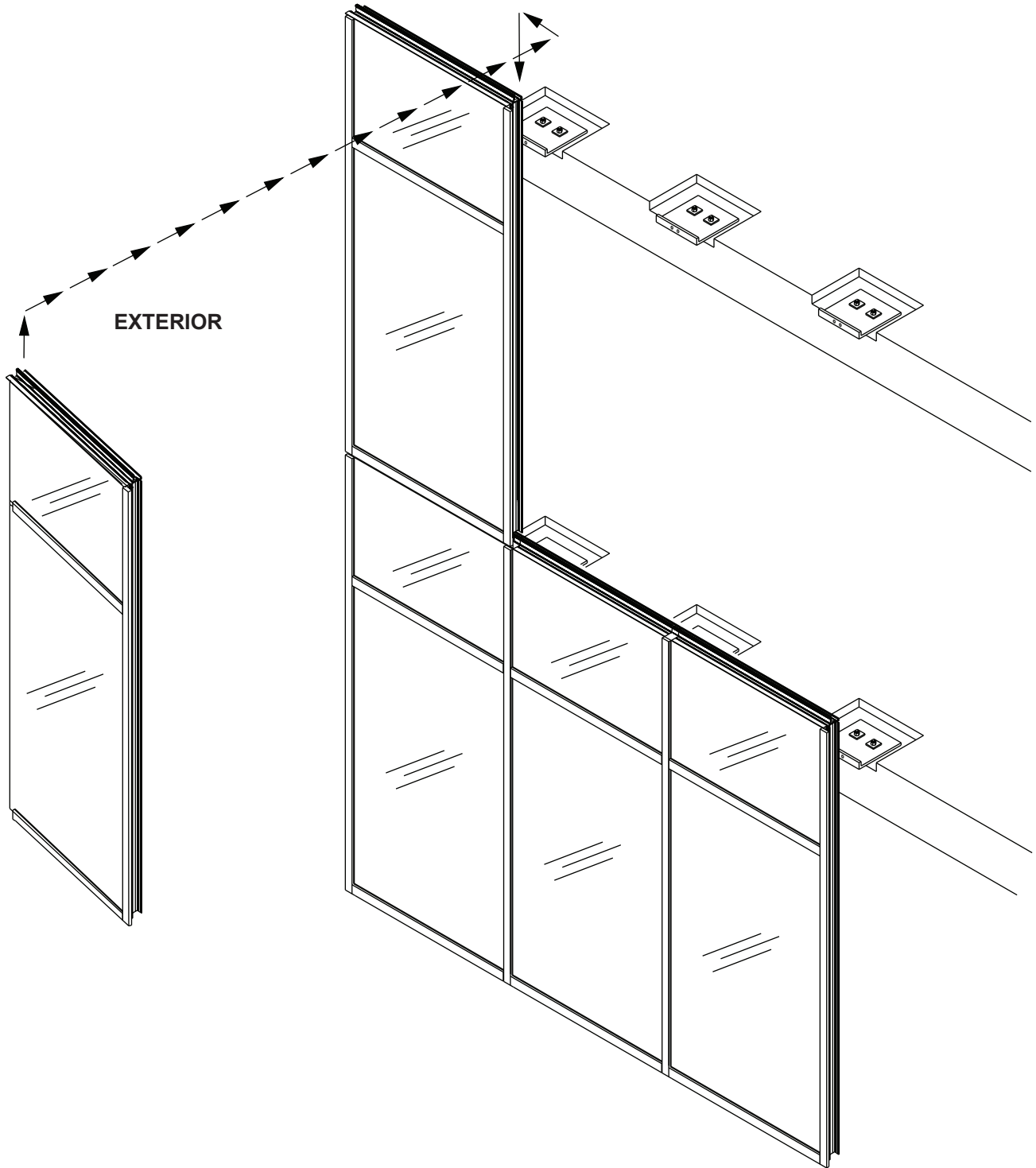

CAPTURED SYSTEM SHOWN

Additional information and CAD details are available at www.kawneer.com

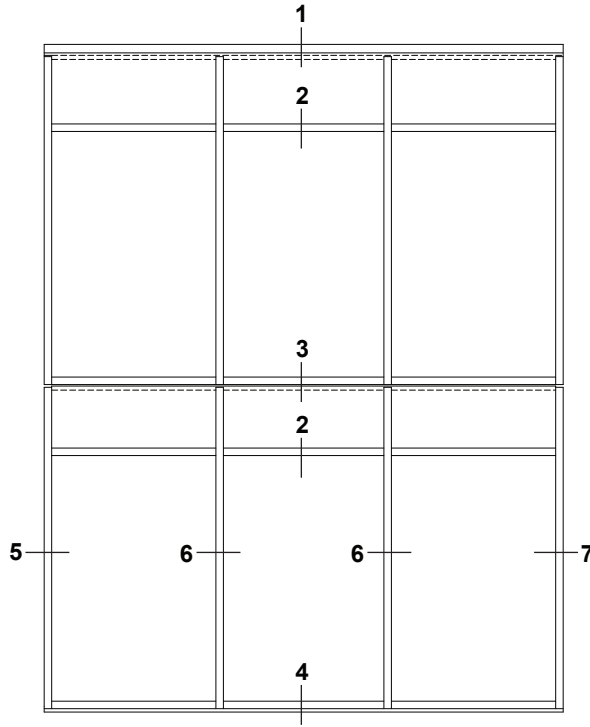

TYPICAL ELEVATION
(CAPTURED SYSTEM)

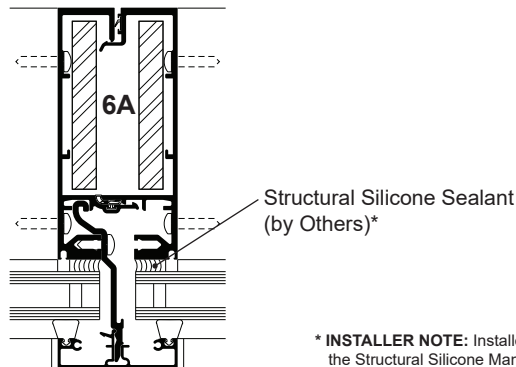
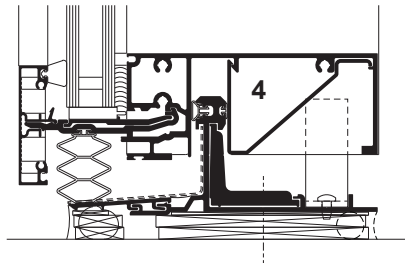
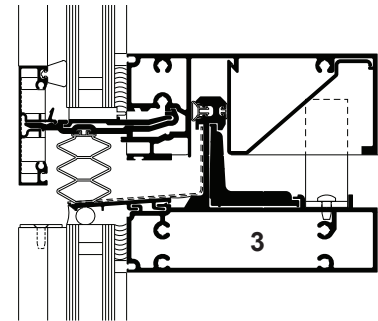
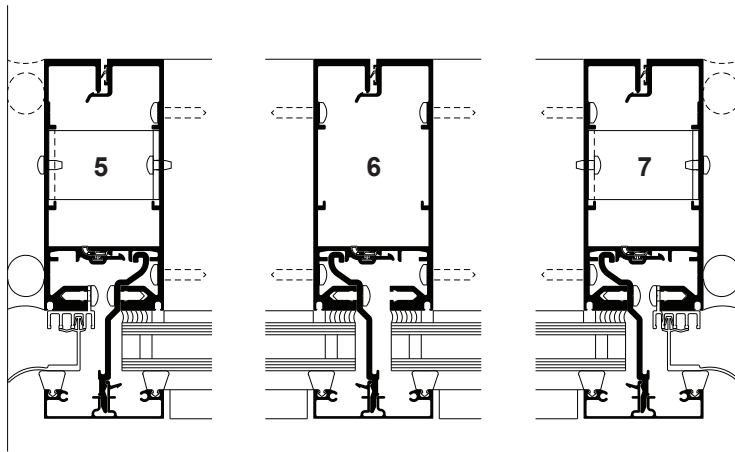
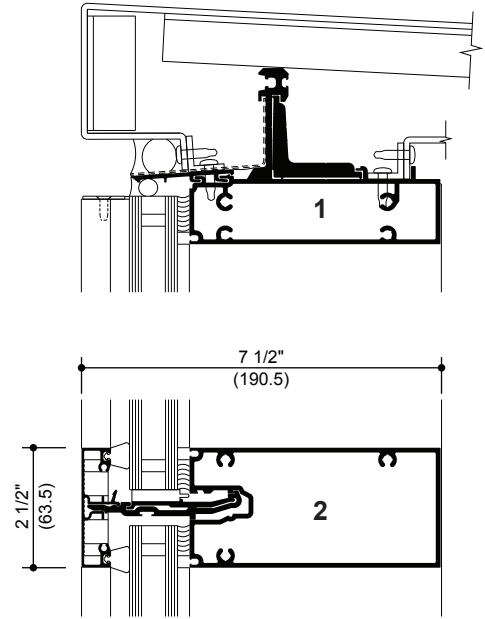

OPTIONAL STEEL
REINFORCING
AS REQUIRED

*** INSTALLER NOTE:** Installer is responsible for all required compatibility review and approvals with the Structural Silicone Manufacturer and the Insulating Glass Unit Manufacturer.

Laws and building and safety codes governing the design and use of Kawneer products, such as glazed entrance, window, and curtain wall products, vary widely. Kawneer does not control the selection of product configurations, operating hardware, or glazing materials, and assumes no responsibility therefor.

Kawneer reserves the right to change configuration without prior notice when deemed necessary for product improvement.
© 2015, Kawneer Company, Inc.

Additional information and CAD details are available at www.kawneer.com

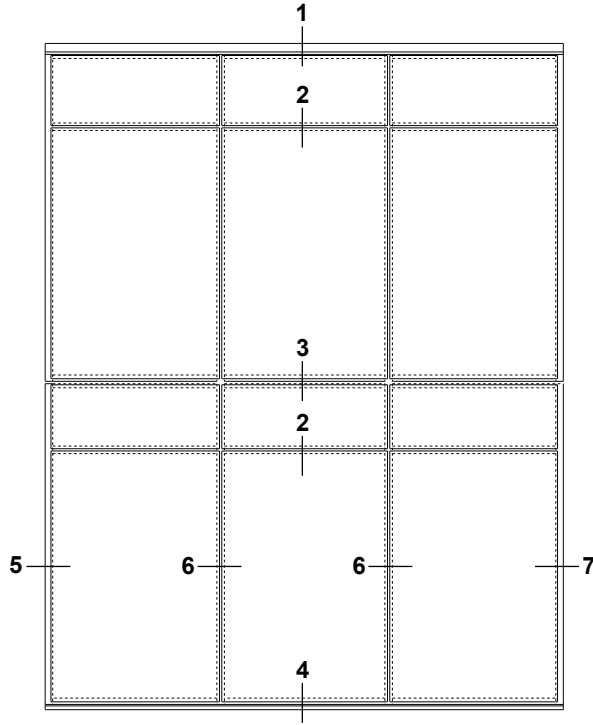

TYPICAL ELEVATION
(4-SIDED SSG SYSTEM)

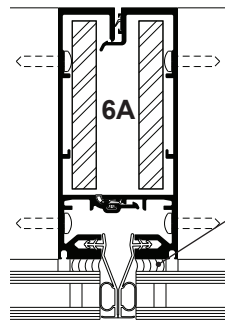
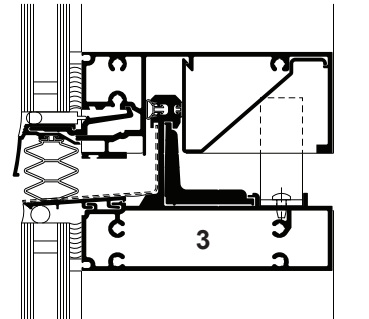
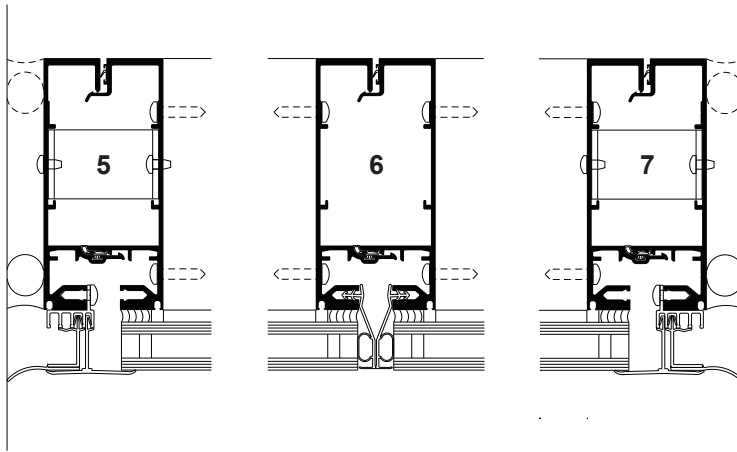
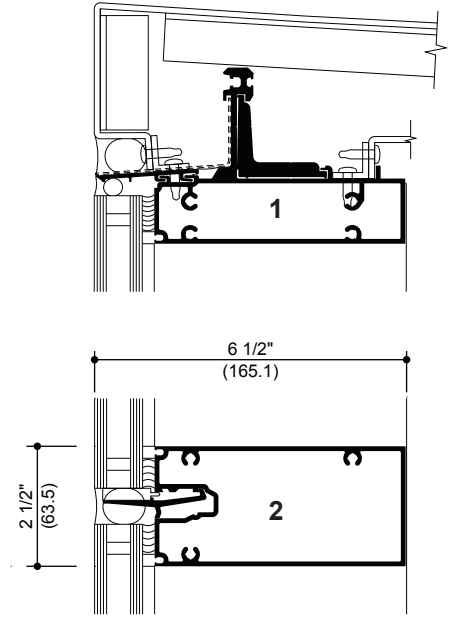

OPTIONAL STEEL
REINFORCING
AS REQUIRED

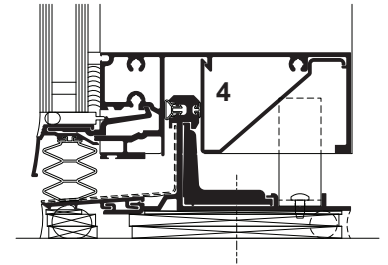

*** INSTALLER NOTE:** Installer is responsible for all required compatibility review and approvals with the Structural Silicone Manufacturer and the Insulating Glass Unit Manufacturer.

Laws and building and safety codes governing the design and use of Kawneer products, such as glazed entrance, window, and curtain wall products, vary widely. Kawneer does not control the selection of product configurations, operating hardware, or glazing materials, and assumes no responsibility therefor.

Kawneer reserves the right to change configuration without prior notice when deemed necessary for product improvement.
© 2015, Kawneer Company, Inc.

Additional information and CAD details are available at www.kawneer.com

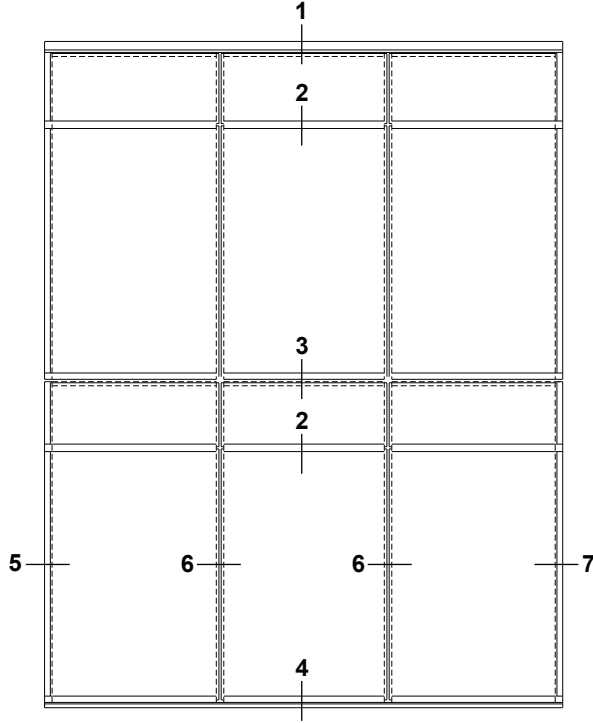

TYPICAL ELEVATION
(VERTICAL SSG SYSTEM)

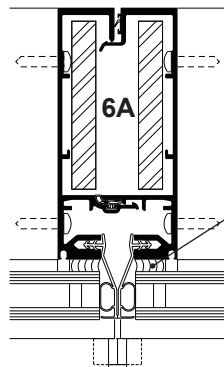
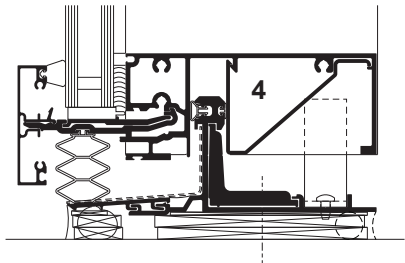
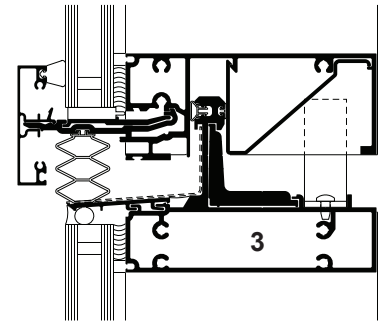
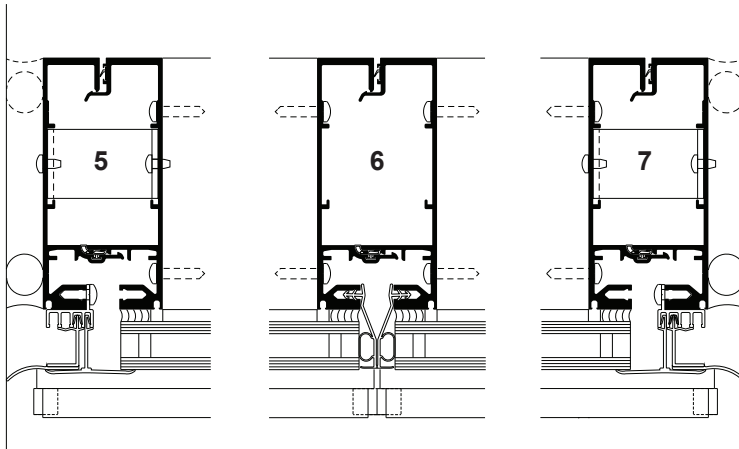
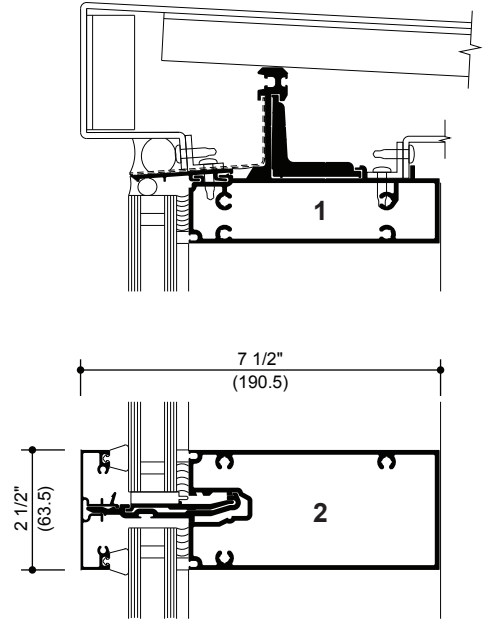

OPTIONAL STEEL
REINFORCING
AS REQUIRED

Structural Silicone Sealant
(by Others)*

*** INSTALLER NOTE:** Installer is responsible for all required compatibility review and approvals with the Structural Silicone Manufacturer and the Insulating Glass Unit Manufacturer.

Laws and building and safety codes governing the design and use of Kawneer products, such as glazed entrance, window, and curtain wall products, vary widely. Kawneer does not control the selection of product configurations, operating hardware, or glazing materials, and assumes no responsibility therefor.

Kawneer reserves the right to change configuration without prior notice when deemed necessary for product improvement.
© 2015, Kawneer Company, Inc.

Additional information and CAD details are available at www.kawneer.com

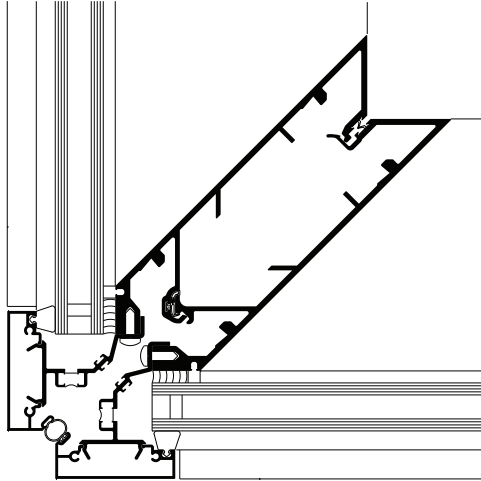

90° OUTSIDE CORNER

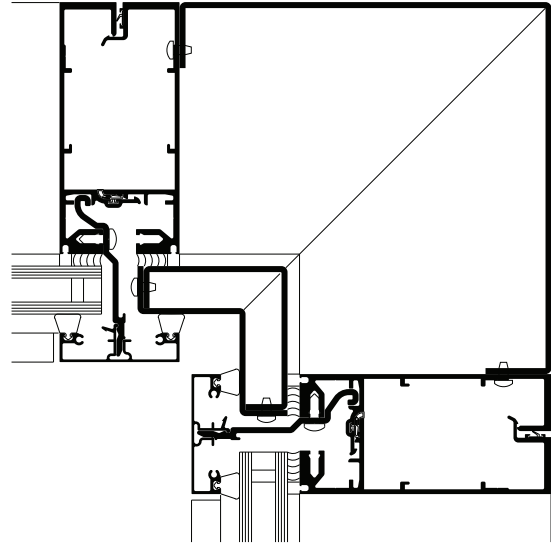

90° INSIDE CORNER

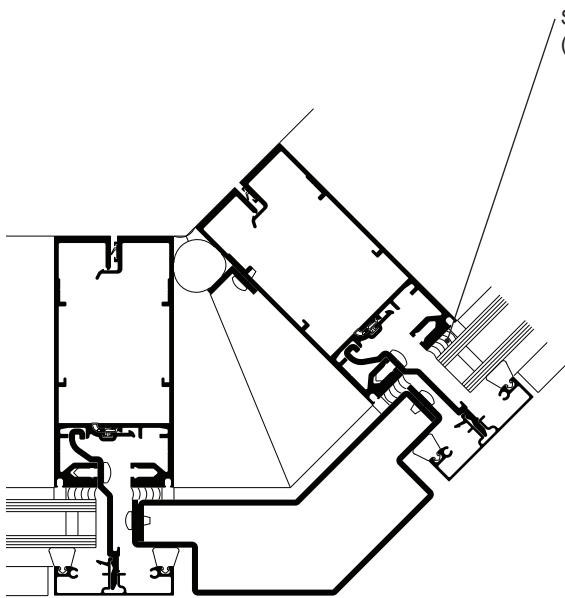

135° OUTSIDE CORNER

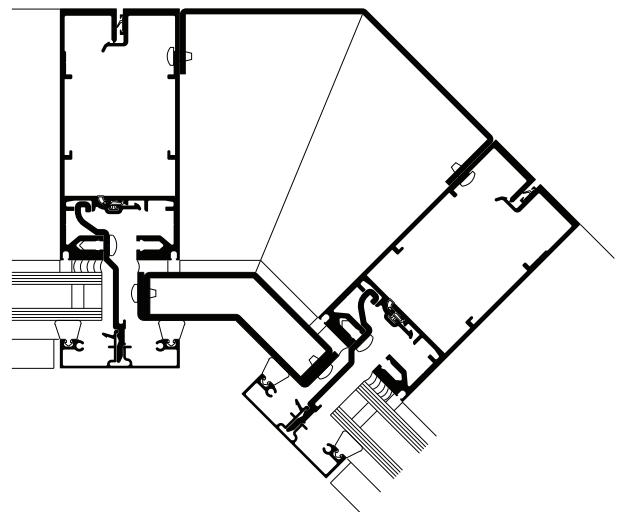

135° INSIDE CORNER

* **INSTALLER NOTE:** Installer is responsible for all required compatibility review and approvals with the Structural Silicone Manufacturer and the Insulating Glass Unit Manufacturer.

Laws and building and safety codes governing the design and use of Kawneer products, such as glazed entrance, window, and curtain wall products, vary widely. Kawneer does not control the selection of product configurations, operating hardware, or glazing materials, and assumes no responsibility therefor.

Kawneer reserves the right to change configuration without prior notice when deemed necessary for product improvement.
© 2015, Kawneer Company, Inc.

Additional information and CAD details are available at www.kawneer.com

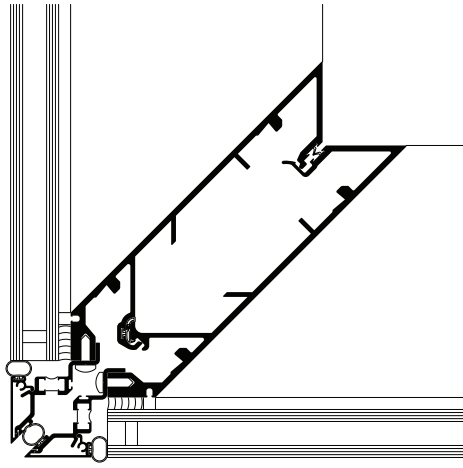

90° SSG OUTSIDE CORNER

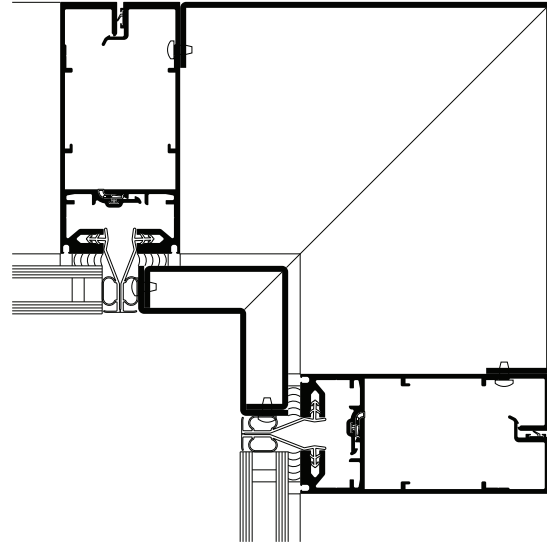

90° SSG INSIDE CORNER

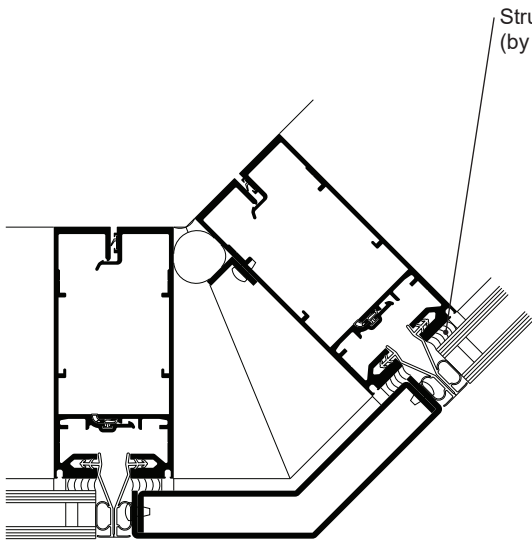

135° SSG OUTSIDE CORNER

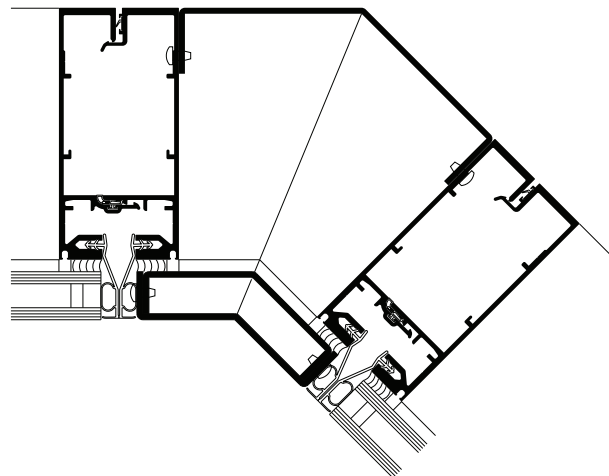

135° SSG INSIDE CORNER

Laws and building and safety codes governing the design and use of Kawneer products, such as glazed entrance, window, and curtain wall products, vary widely. Kawneer does not control the selection of product configurations, operating hardware, or glazing materials, and assumes no responsibility therefor.

Kawneer reserves the right to change configuration without prior notice when deemed necessary for product improvement.
© 2015, Kawneer Company, Inc.

* INSTALLER NOTE: Installer is responsible for all required compatibility review and approvals with the Structural Silicone Manufacturer and the Insulating Glass Unit Manufacturer.

Additional information and CAD details are available at www.kawneer.com

Laws and building and safety codes governing the design and use of Kawneer products, such as glazed entrance, window, and curtain wall products, vary widely. Kawneer does not control the selection of product configurations, operating hardware, or glazing materials, and assumes no responsibility therefor.

Kawneer reserves the right to change configuration without prior notice when deemed necessary for product improvement.
© 2015, Kawneer Company, Inc.

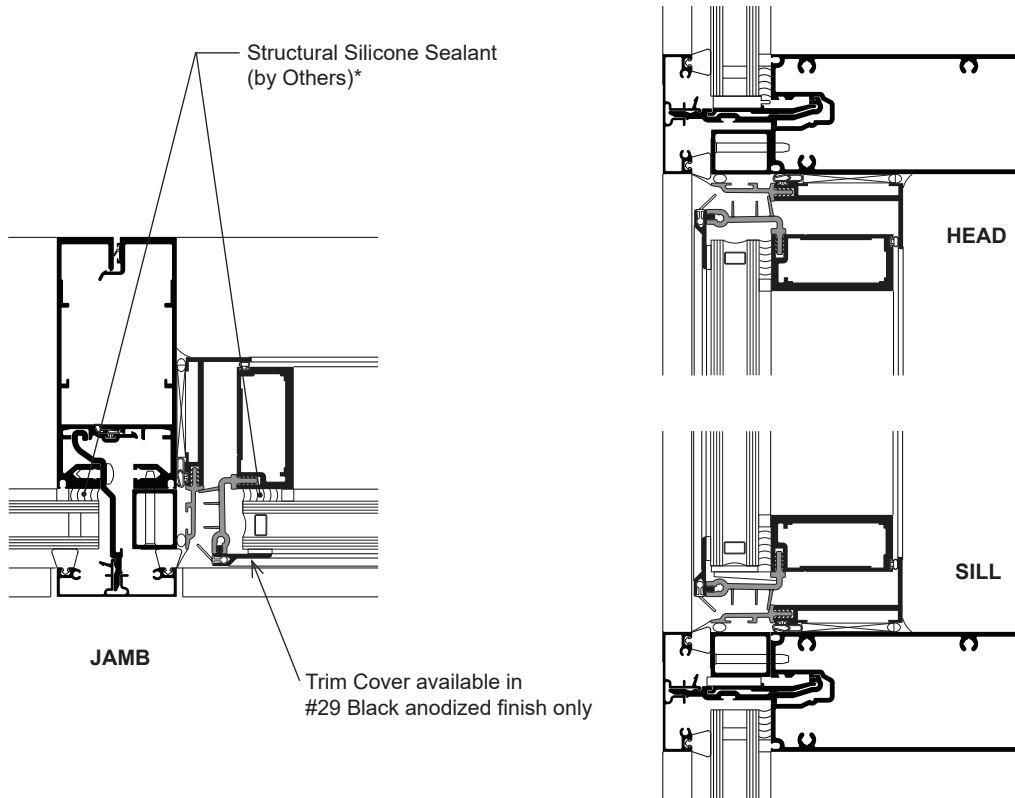
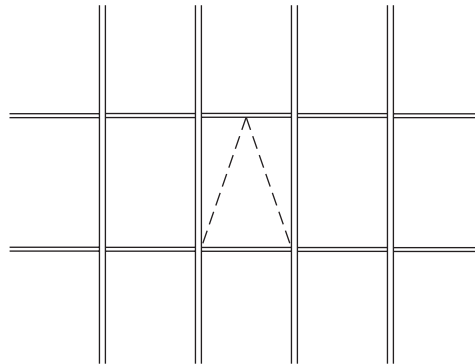

**Project-Out GLASSvent® UT Window Shown
Casement Window Similar**

(With Captured System Only)

*** INSTALLER NOTE:** Installer is responsible for all required compatibility review and approvals with the Structural Silicone Manufacturer and the Insulating Glass Unit Manufacturer.

Additional information and CAD details are available at www.kawneer.com

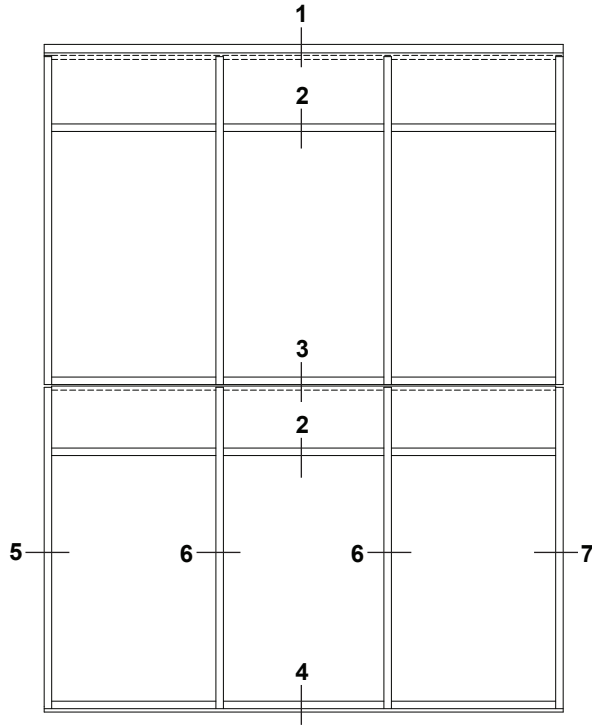

TYPICAL ELEVATION
(CAPTURED SYSTEM)

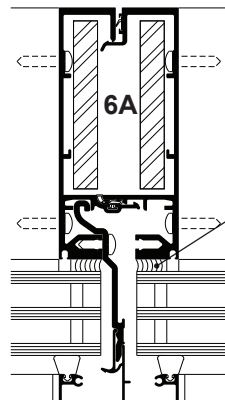
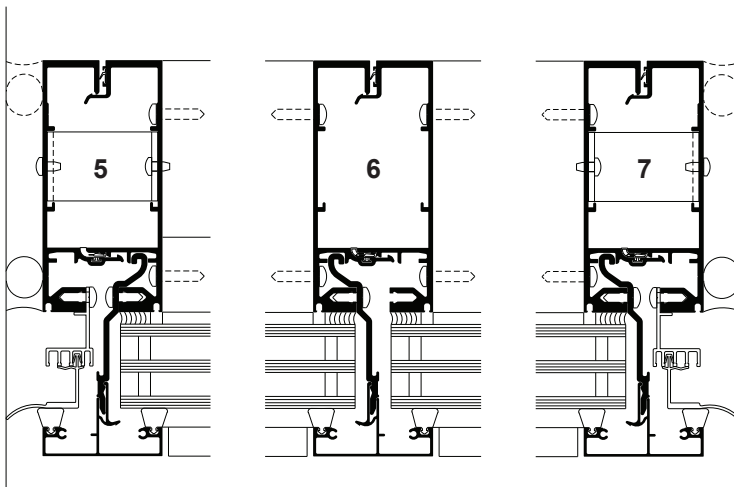
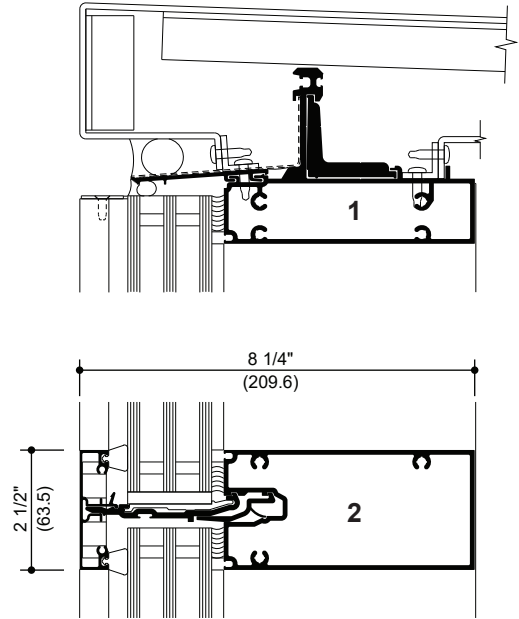

Structural Silicone Sealant
(by Others)*

OPTIONAL STEEL
REINFORCING
AS REQUIRED

* **INSTALLER NOTE:** Installer is responsible for all required compatibility review and approvals with the Structural Silicone Manufacturer and the Insulating Glass Unit Manufacturer.

Laws and building and safety codes governing the design and use of Kawneer products, such as glazed entrance, window, and curtain wall products, vary widely. Kawneer does not control the selection of product configurations, operating hardware, or glazing materials, and assumes no responsibility therefor.

Kawneer reserves the right to change configuration without prior notice when deemed necessary for product improvement.
© 2015, Kawneer Company, Inc.

Additional information and CAD details are available at www.kawneer.com

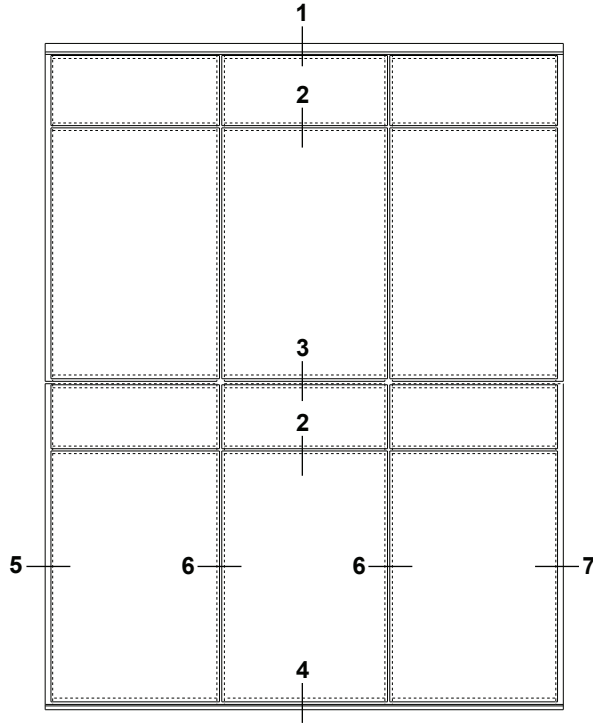

TYPICAL ELEVATION
(4-SIDED SSG SYSTEM)

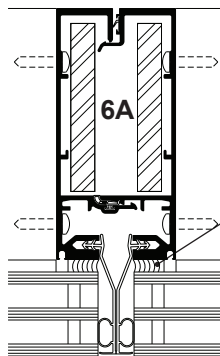
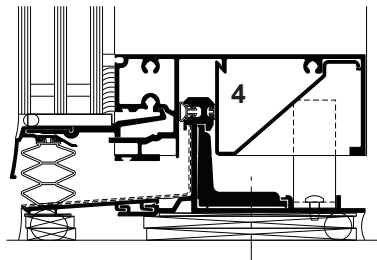
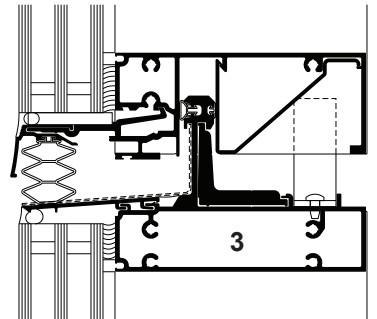
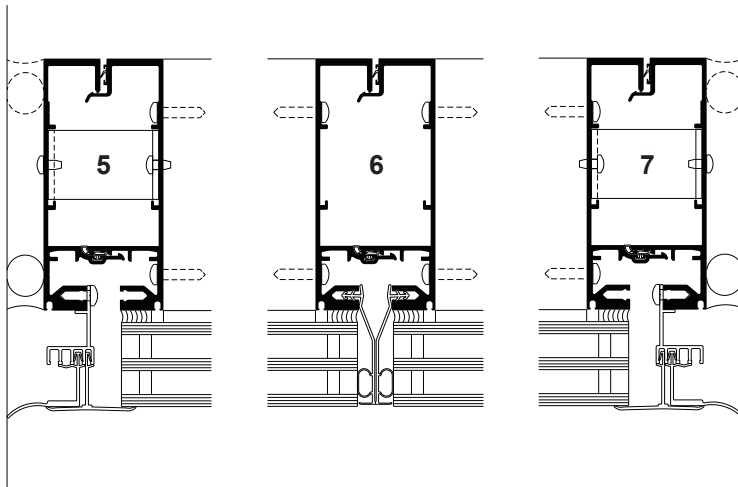
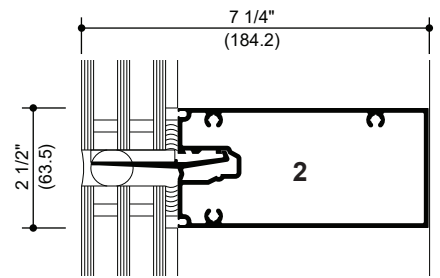
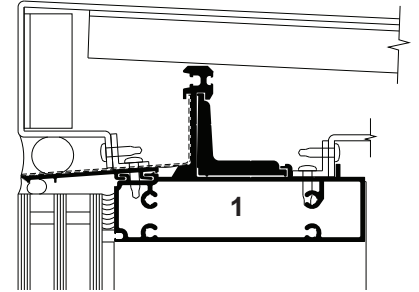

OPTIONAL STEEL
REINFORCING
AS REQUIRED

Structural Silicone Sealant
(by Others)*

* **INSTALLER NOTE:** Installer is responsible for all required compatibility review and approvals with the Structural Silicone Manufacturer and the Insulating Glass Unit Manufacturer.

Laws and building and safety codes governing the design and use of Kawneer products, such as glazed entrance, window, and curtain wall products, vary widely. Kawneer does not control the selection of product configurations, operating hardware, or glazing materials, and assumes no responsibility therefor.

Kawneer reserves the right to change configuration without prior notice when deemed necessary for product improvement.
© 2015, Kawneer Company, Inc.

Additional information and CAD details are available at www.kawneer.com

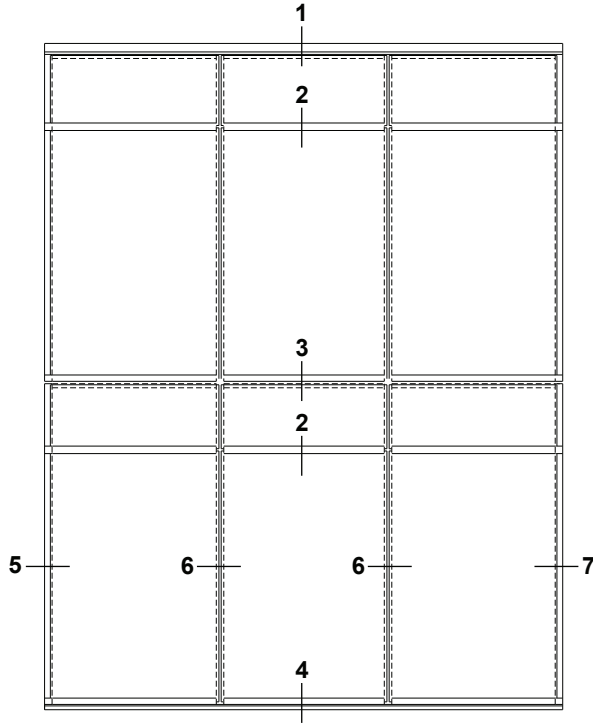

TYPICAL ELEVATION
(VERTICAL SSG SYSTEM)

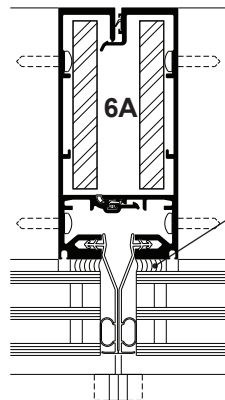
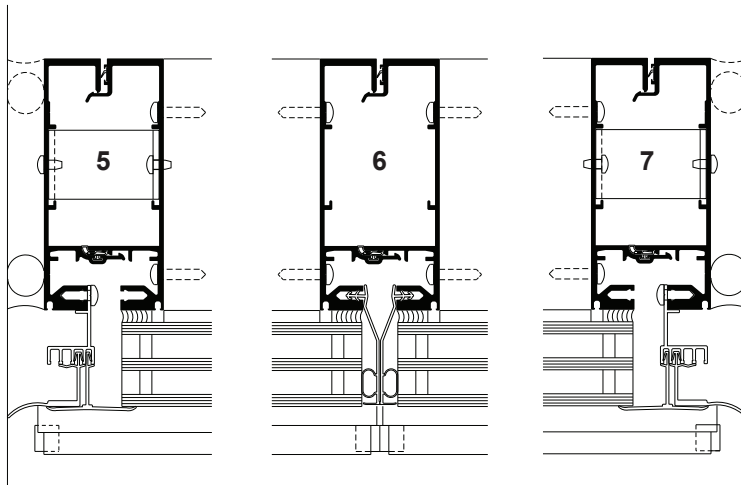
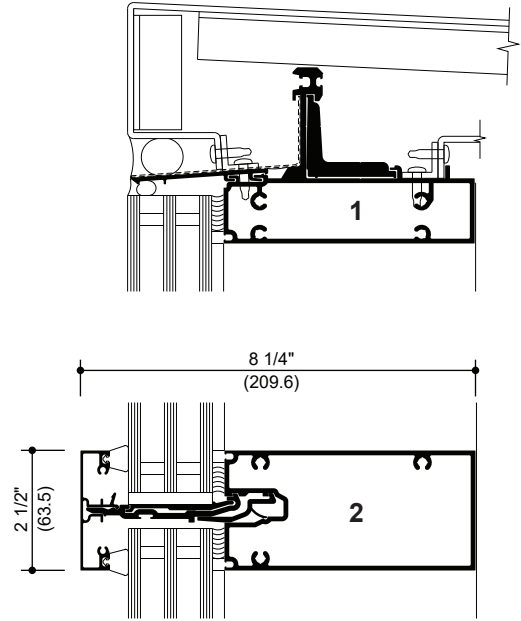

OPTIONAL STEEL
REINFORCING
AS REQUIRED

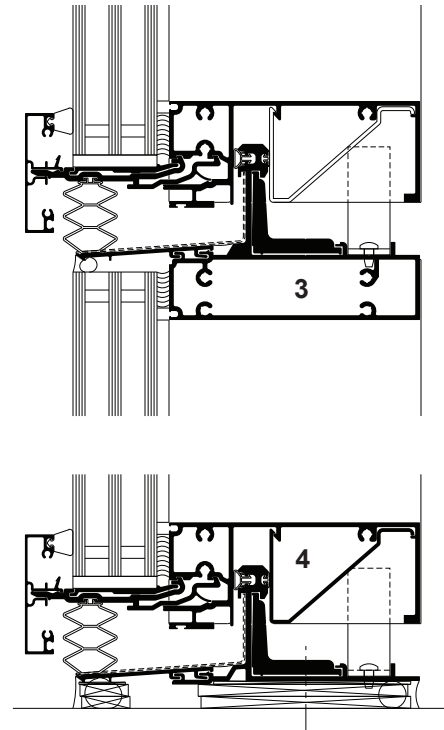

* **INSTALLER NOTE:** Installer is responsible for all required compatibility review and approvals with the Structural Silicone Manufacturer and the Insulating Glass Unit Manufacturer.

Laws and building and safety codes governing the design and use of Kawneer products, such as glazed entrance, window, and curtain wall products, vary widely. Kawneer does not control the selection of product configurations, operating hardware, or glazing materials, and assumes no responsibility therefor.

Kawneer reserves the right to change configuration without prior notice when deemed necessary for product improvement.
© 2015, Kawneer Company, Inc.

Additional information and CAD details are available at www.kawneer.com

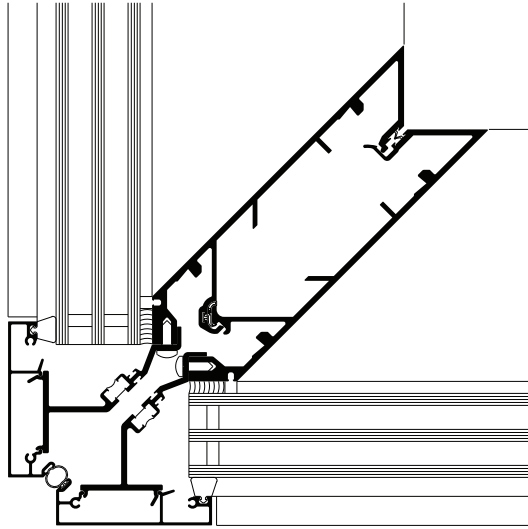

90° OUTSIDE CORNER

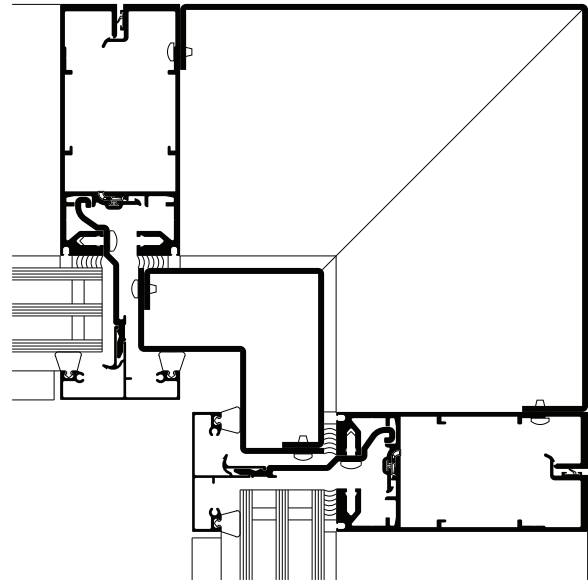

90° INSIDE CORNER

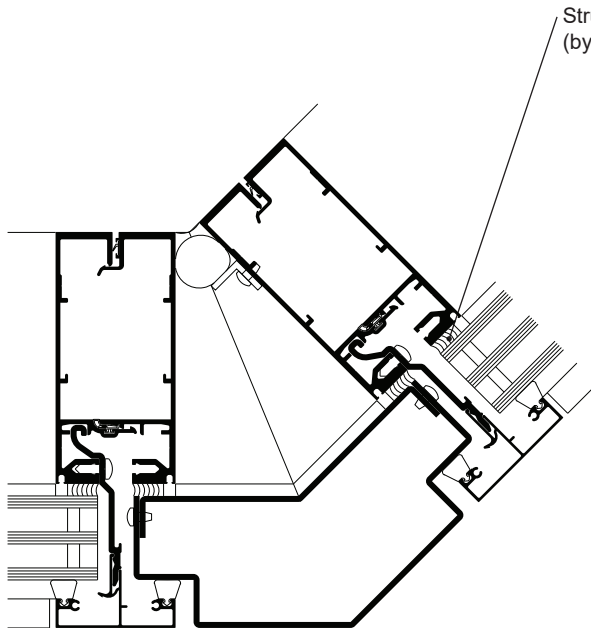

135° OUTSIDE CORNER

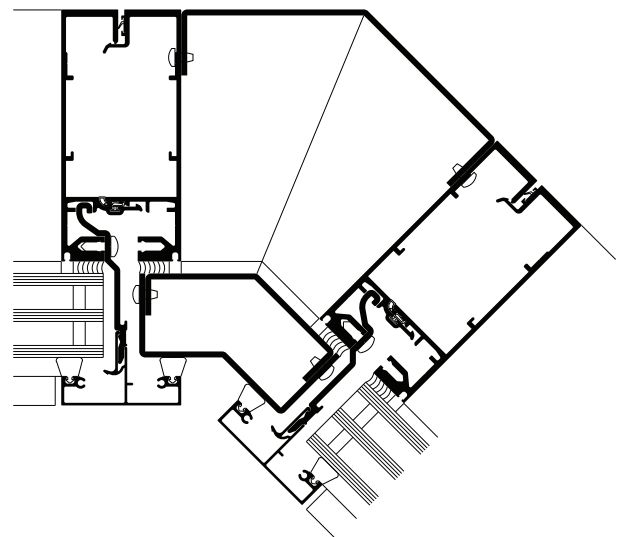

135° INSIDE CORNER

* **INSTALLER NOTE:** Installer is responsible for all required compatibility review and approvals with the Structural Silicone Manufacturer and the Insulating Glass Unit Manufacturer.

Laws and building and safety codes governing the design and use of Kawneer products, such as glazed entrance, window, and curtain wall products, vary widely. Kawneer does not control the selection of product configurations, operating hardware, or glazing materials, and assumes no responsibility therefor.

Kawneer reserves the right to change configuration without prior notice when deemed necessary for product improvement.
© 2015, Kawneer Company, Inc.

Additional information and CAD details are available at www.kawneer.com

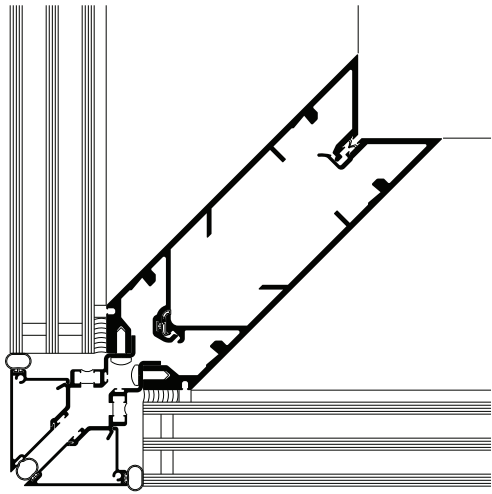

90° SSG OUTSIDE CORNER

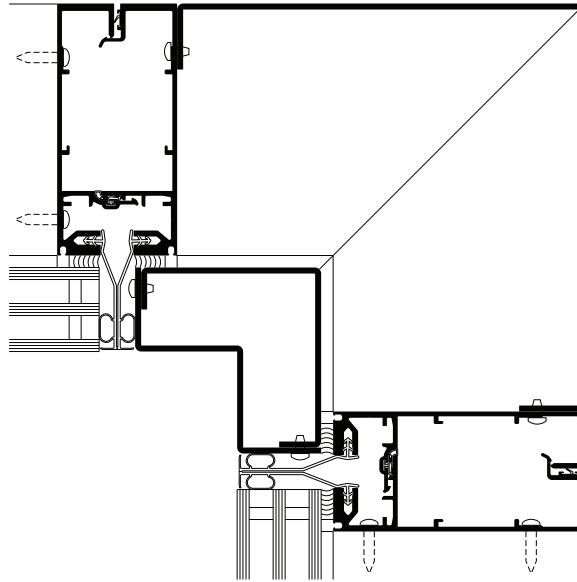

90° SSG INSIDE CORNER

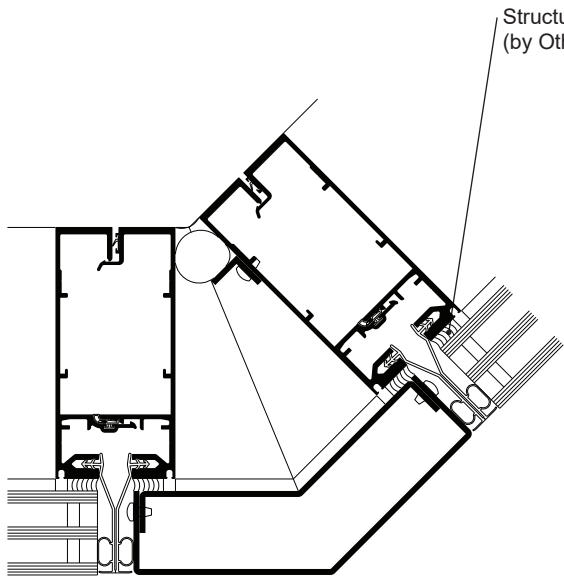

135° SSG OUTSIDE CORNER

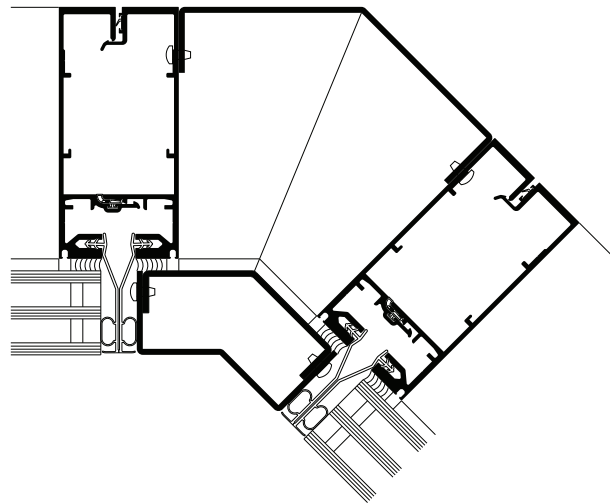

135° SSG INSIDE CORNER

* INSTALLER NOTE: Installer is responsible for all required compatibility review and approvals with the Structural Silicone Manufacturer and the Insulating Glass Unit Manufacturer.

Laws and building and safety codes governing the design and use of Kawneer products, such as glazed entrance, window, and curtain wall products, vary widely. Kawneer does not control the selection of product configurations, operating hardware, or glazing materials, and assumes no responsibility therefor.

Kawneer reserves the right to change configuration without prior notice when deemed necessary for product improvement.
© 2015, Kawneer Company, Inc.

Additional information and CAD details are available at www.kawneer.com

Laws and building and safety codes governing the design and use of Kawneer products, such as glazed entrance, window, and curtain wall products, vary widely. Kawneer does not control the selection of product configurations, operating hardware, or glazing materials, and assumes no responsibility therefor.

Kawneer reserves the right to change configuration without prior notice when deemed necessary for product improvement.
© 2015, Kawneer Company, Inc.

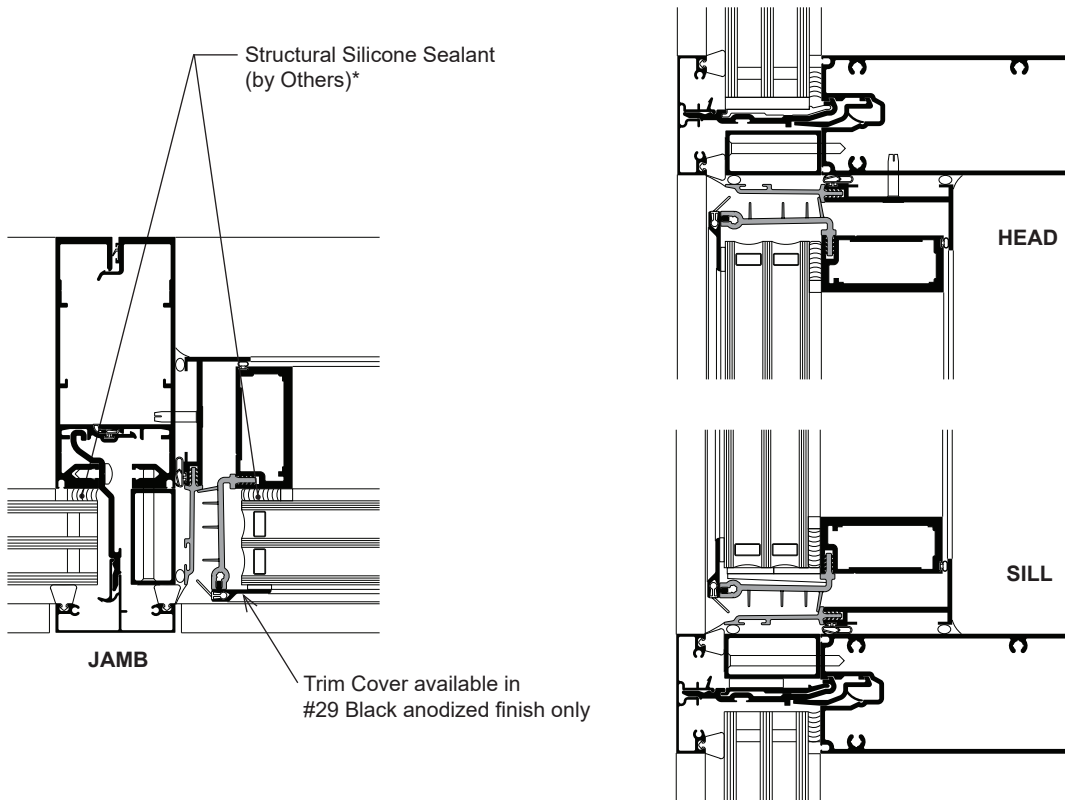
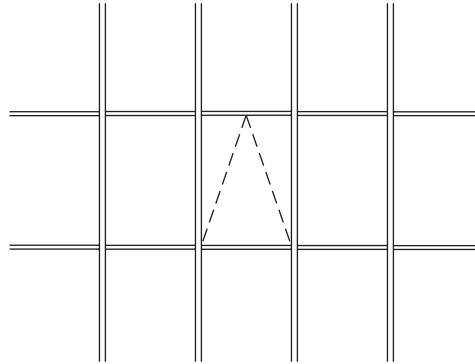

**Project-Out GLASSvent® UT Window Shown
Casement Window Similar**

(With Captured System Only)

*** INSTALLER NOTE:** Installer is responsible for all required compatibility review and approvals with the Structural Silicone Manufacturer and the Insulating Glass Unit Manufacturer.

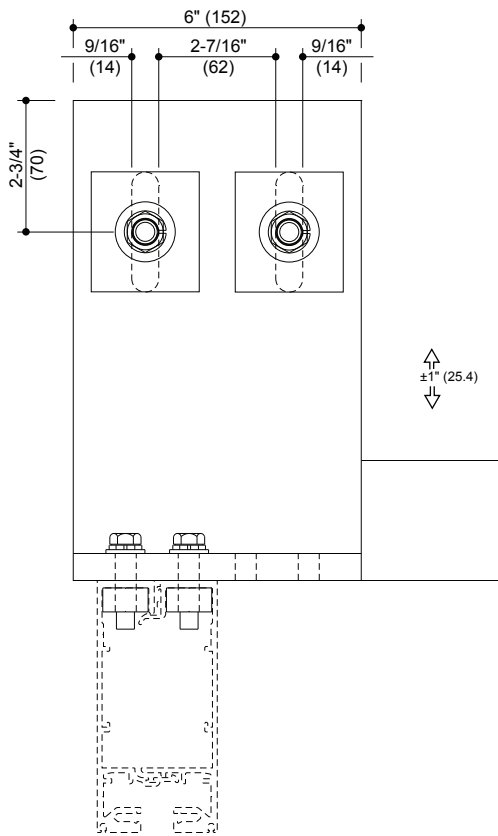
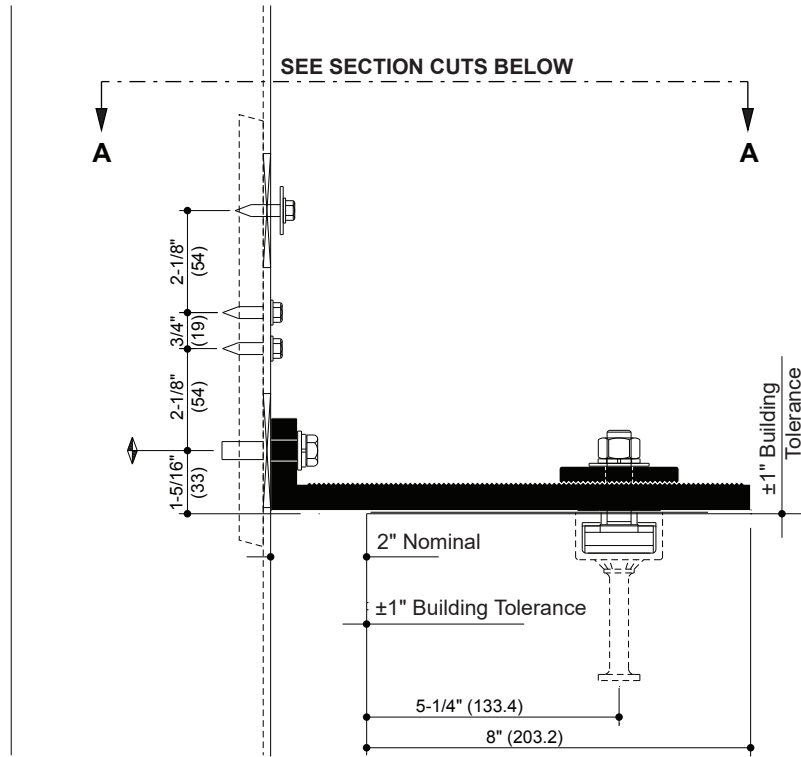

ANCHOR AT JAMB

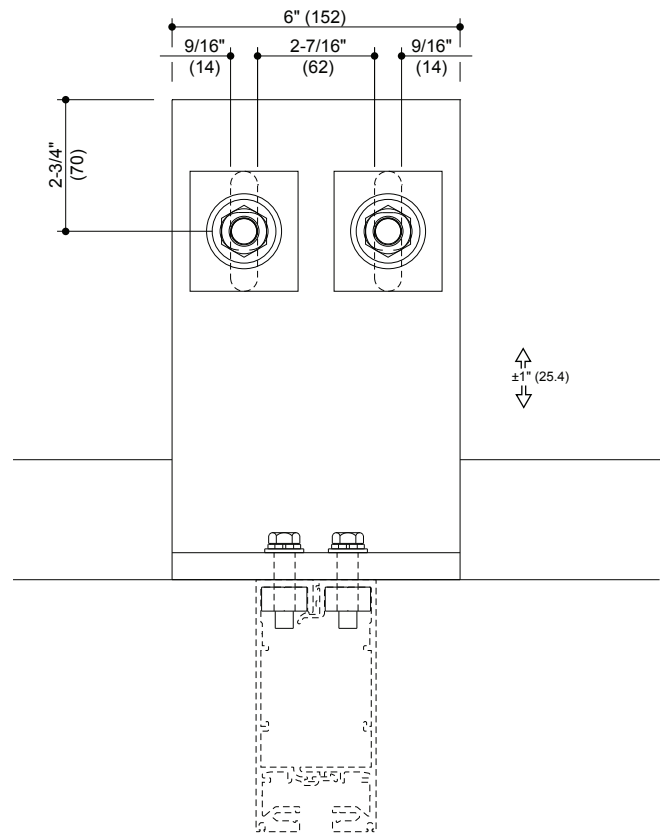

ANCHOR AT MULLION

Laws and building and safety codes governing the design and use of Kawneer products, such as glazed entrance, window, and curtain wall products, vary widely. Kawneer does not control the selection of product configurations, operating hardware, or glazing materials, and assumes no responsibility therefor.

Kawneer reserves the right to change configuration without prior notice when deemed necessary for product improvement.
© 2015, Kawneer Company, Inc.

WIND LOAD CHARTS

Mullions are designed for deflection limitations in accordance with AAMA TIR-A11 of L/175 up to 13' 6" and L/240 +1/4" above 13' 6". These curves are for mullions WITH HORIZONTALS and are based on engineering calculations for stress and deflection. Allowable wind load stress for ALUMINUM 12,000 psi (82.74 MPa), STEEL 20,000 psi (137.90 MPa). Charted curves, in all cases are for the limiting value. Wind load charts contained herein are based upon nominal wind load utilized in allowable stress design. A conversion from Load Resistance Factor Design (LRFD) is provided. To convert ultimate wind loads to nominal loads, multiply ultimate wind loads by a factor of 0.6 per ASCE/SEI 7. A 4/3 increase in allowable stress has not been used to develop these curves. For special situations not covered by these curves, contact your Kawneer representative for additional information.

DEADLOAD CHARTS

Horizontal or deadload limitations are based upon 1/8" (3.2), maximum allowable deflection at the center of an intermediate horizontal member. The accompanying charts are calculated for 1" (25.4) thick insulating glass or 1-3/4" (44.5) thick glass supported on two setting blocks placed at the loading points shown.

Laws and building and safety codes governing the design and use of Kawneer products, such as glazed entrance, window, and curtain wall products, vary widely. Kawneer does not control the selection of product configurations, operating hardware, or glazing materials, and assumes no responsibility therefor.

Kawneer reserves the right to change configuration without prior notice when deemed necessary for product improvement.
© 2015, Kawneer Company, Inc.

When mullion is used in a SSG application, curves become straight due to structural silicone limits, represented by dashed lines on chart. *Charts are for typical spans, not beginning or ending spans. C/L of stack horizontal to be at noted stool height above C/L of anchor.

----- SSG Structural Silicone Limit - Silicone joint contact is .625".

	Allowable Stress Design Load	LRFD Ultimate Design Load
A =	20 PSF (960)	33 PSF (1580)
B =	30 PSF (1440)	50 PSF (2400)
C =	40 PSF (1920)	67 PSF (3200)
D =	50 PSF (2400)	83 PSF (4000)
E =	60 PSF (2880)	100 PSF (4790)

SINGLE SPAN

MULLION CENTERS IN METERS

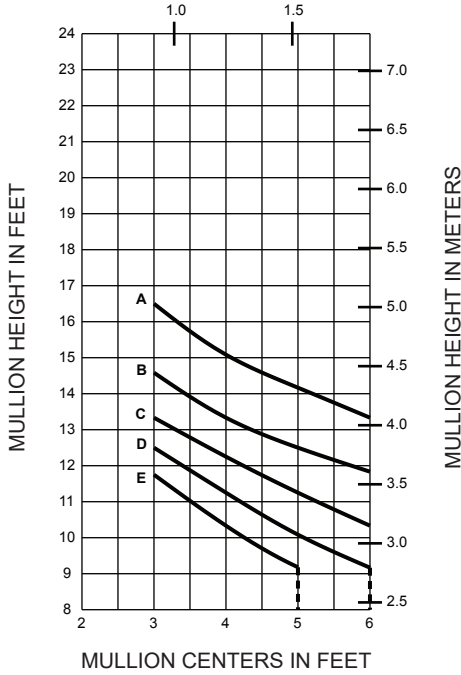

***MULTI-SPAN
24" SPLICE LOCATION**

MULLION CENTERS IN METERS

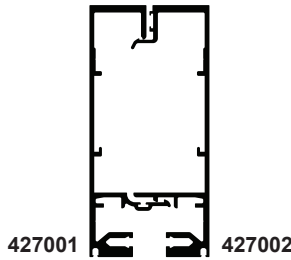
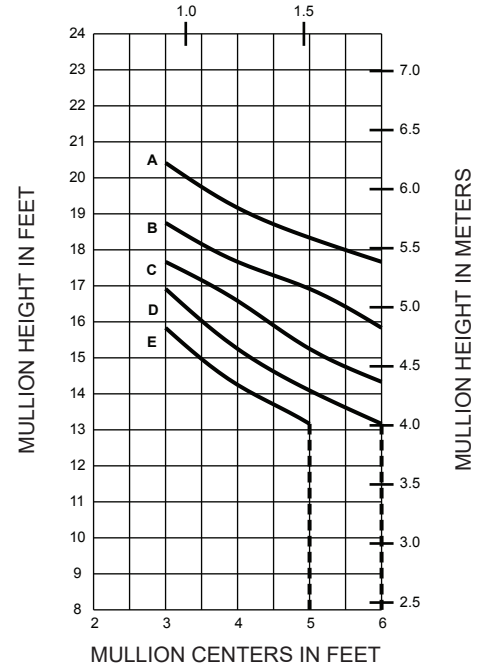

$I = 9.424 (392.25 \times 10^4)$
 $S = 3.208 (52.57 \times 10^3)$

***MULTI-SPAN
30" SPLICE LOCATION**

MULLION CENTERS IN METERS

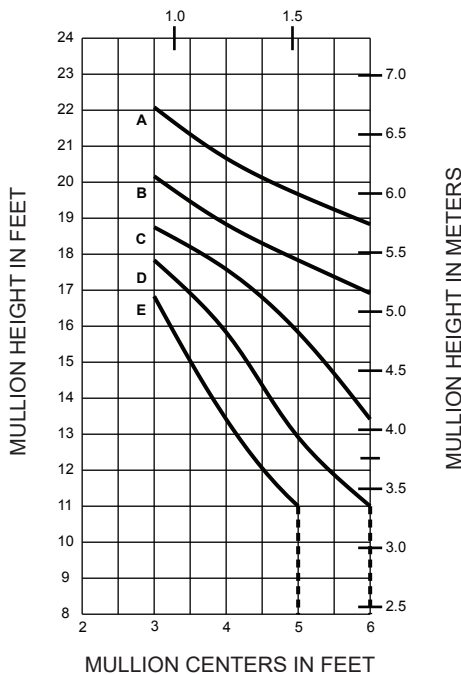

***MULTI-SPAN
36" SPLICE LOCATION**

MULLION CENTERS IN METERS

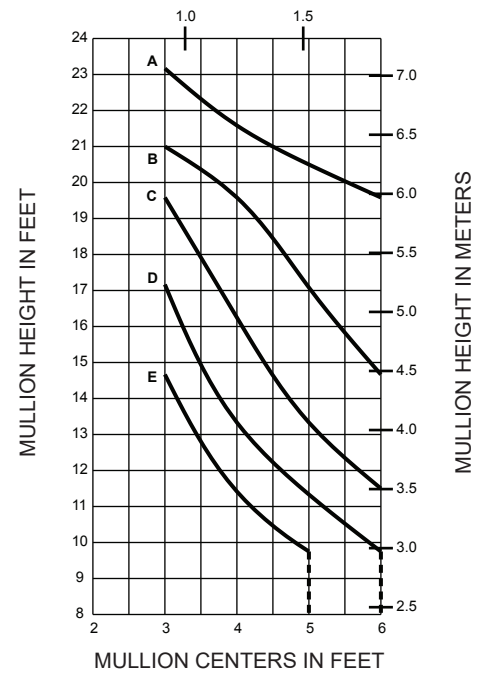

Laws and building and safety codes governing the design and use of Kawneer products, such as glazed entrance, window, and curtain wall products, vary widely. Kawneer does not control the selection of product configurations, operating hardware, or glazing materials, and assumes no responsibility therefor.

Kawneer reserves the right to change configuration without prior notice when deemed necessary for product improvement.
 © 2015, Kawneer Company, Inc.

When mullion is used in a SSG application, curves become straight due to structural silicone limits, represented by dashed lines on chart. *Charts are for typical spans, not beginning or ending spans. C/L of stack horizontal to be at noted stool height above C/L of anchor.

----- SSG Structural Silicone Limit - Silicone joint contact is .625".

SINGLE SPAN
with 1/2" x 3-1/2" Steel Bar

MULLION CENTERS IN METERS

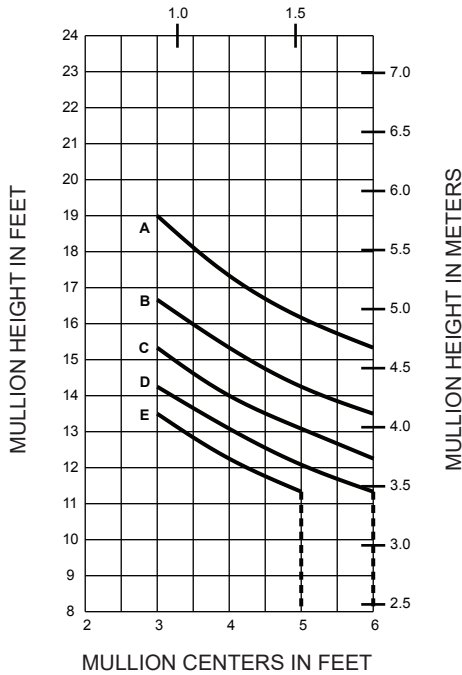

	Allowable Stress Design Load	LRFD Ultimate Design Load
A =	20 PSF (960)	33 PSF (1580)
B =	30 PSF (1440)	50 PSF (2400)
C =	40 PSF (1920)	67 PSF (3200)
D =	50 PSF (2400)	83 PSF (4000)
E =	60 PSF (2880)	100 PSF (4790)

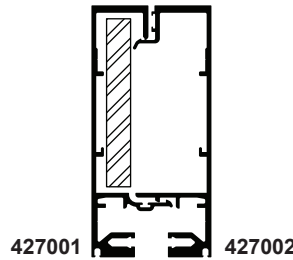

WITH 1/2" x 3-1/2" STEEL BAR

(Aluminum)
I = 9.424 (392.25 x 10⁴)
S = 3.208 (52.57 x 10³)

(Steel)
I = 1.786 (74.34 x 10⁴)
S = 1.021 (16.73 x 10³)

***MULTI-SPAN 24" SPLICE LOCATION**
with 1/2" x 3-1/2" Steel Bar

MULLION CENTERS IN METERS

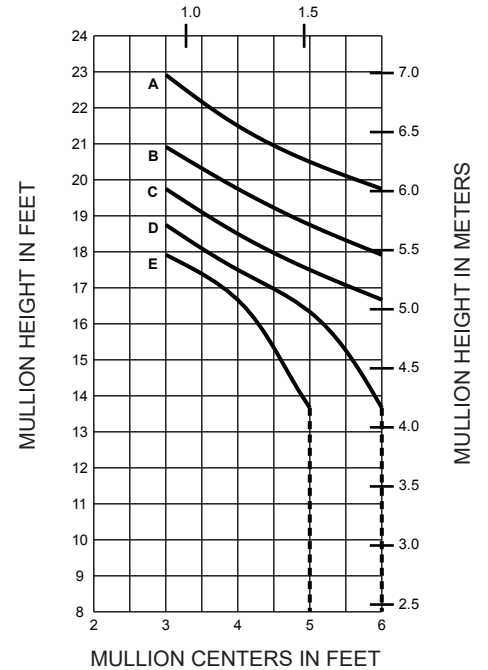

***MULTI-SPAN 30" SPLICE LOCATION**
with 1/2" x 3-1/2" Steel Bar

MULLION CENTERS IN METERS

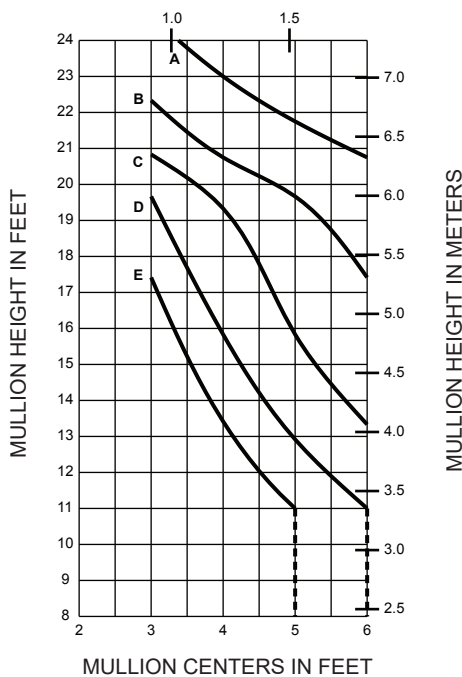

***MULTI-SPAN 36" SPLICE LOCATION**
with 1/2" x 3-1/2" Steel Bar

MULLION CENTERS IN METERS

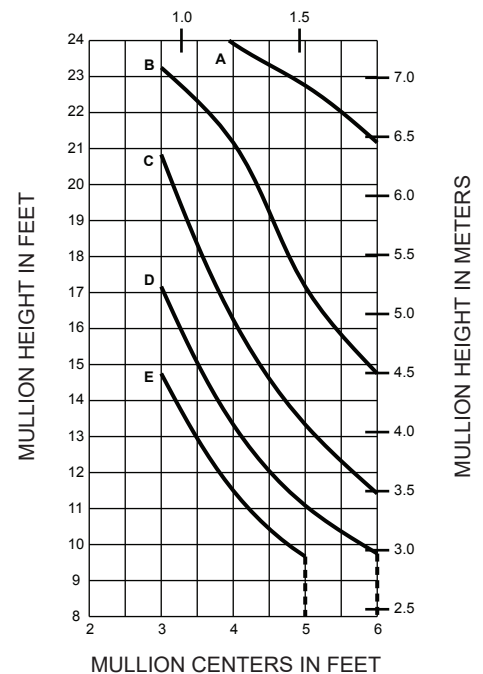

Laws and building and safety codes governing the design and use of Kawneer products, such as glazed entrance, window, and curtain wall products, vary widely. Kawneer does not control the selection of product configurations, operating hardware, or glazing materials, and assumes no responsibility therefor.

Kawneer reserves the right to change configuration without prior notice when deemed necessary for product improvement.
© 2015, Kawneer Company, Inc.

When mullion is used in a SSG application, curves become straight due to structural silicone limits, represented by dashed lines on chart. *Charts are for typical spans, not beginning or ending spans. C/L of stack horizontal to be at noted stool height above C/L of anchor.

----- SSG Structural Silicone Limit - Silicone joint contact is .625".

SINGLE SPAN
with (2) 1/2" x 3-1/2" Steel Bars

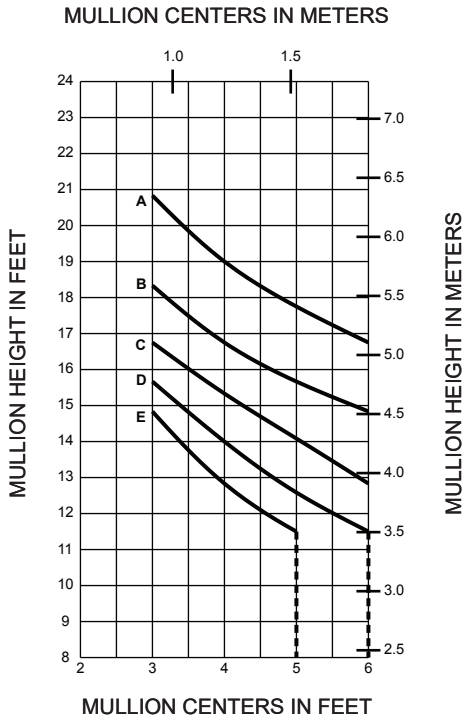

	Allowable Stress Design Load	LRFD Ultimate Design Load
A =	20 PSF (960)	33 PSF (1580)
B =	30 PSF (1440)	50 PSF (2400)
C =	40 PSF (1920)	67 PSF (3200)
D =	50 PSF (2400)	83 PSF (4000)
E =	60 PSF (2880)	100 PSF (4790)

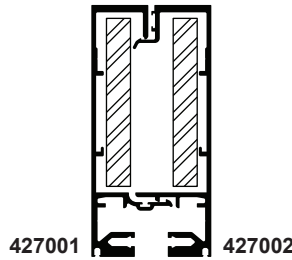

WITH (2) 1/2" x 3-1/2" STEEL BARS

(Aluminum)

$I = 9.424 (392.25 \times 10^4)$
 $S = 3.208 (52.57 \times 10^3)$

(Steel)

$I = 3.572 (148.67 \times 10^4)$
 $S = 2.041 (33.44 \times 10^3)$

***MULTI-SPAN 24" SPLICE LOCATION**
with (2) 1/2" x 3-1/2" Steel Bars

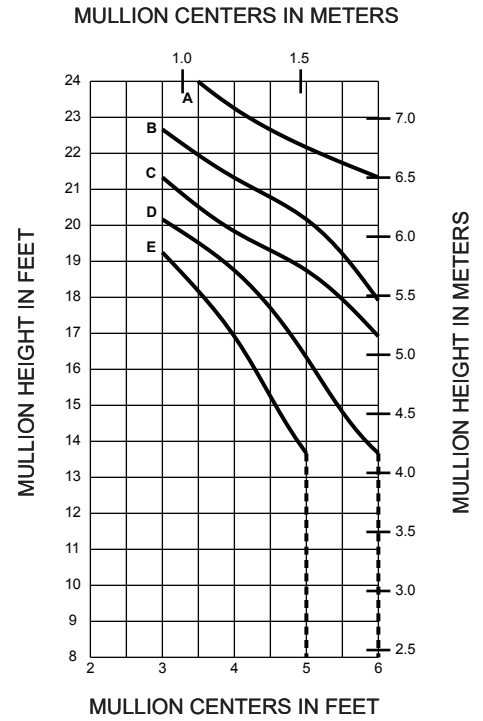

***MULTI-SPAN 30" SPLICE LOCATION**
with (2) 1/2" x 3-1/2" Steel Bars

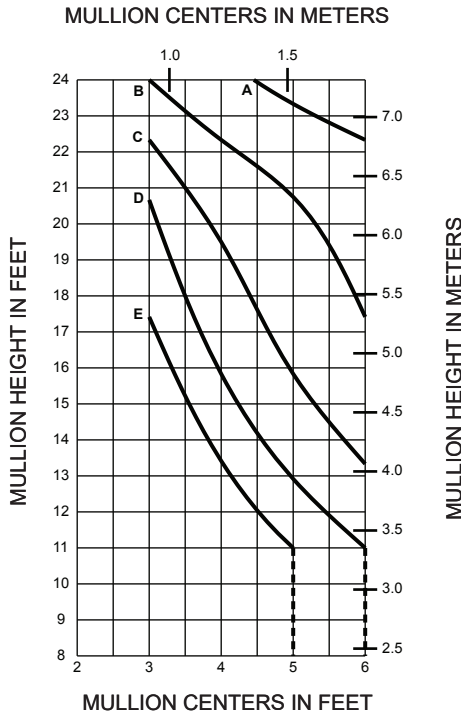

***MULTI-SPAN 36" SPLICE LOCATION**
with (2) 1/2" x 3-1/2" Steel Bars

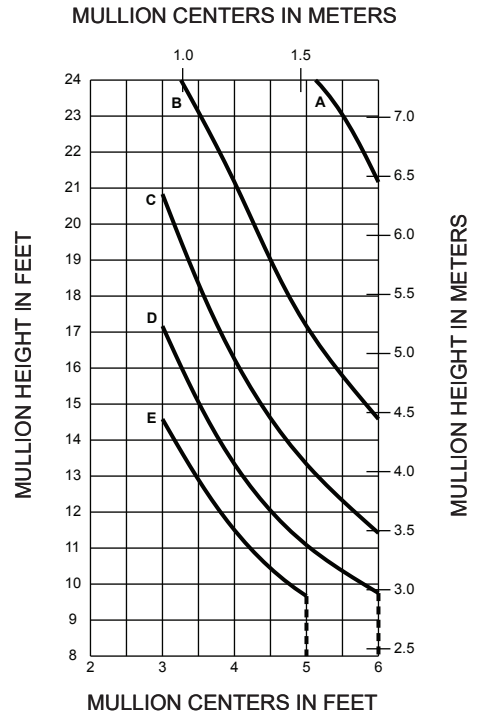

Laws and building and safety codes governing the design and use of Kawneer products, such as glazed entrance, window, and curtain wall products, vary widely. Kawneer does not control the selection of product configurations, operating hardware, or glazing materials, and assumes no responsibility therefor.

Kawneer reserves the right to change configuration without prior notice when deemed necessary for product improvement.
© 2015, Kawneer Company, Inc.

A = 1" GLASS (1/4 POINT LOADING)
 B = 1" GLASS (1/8 POINT LOADING)

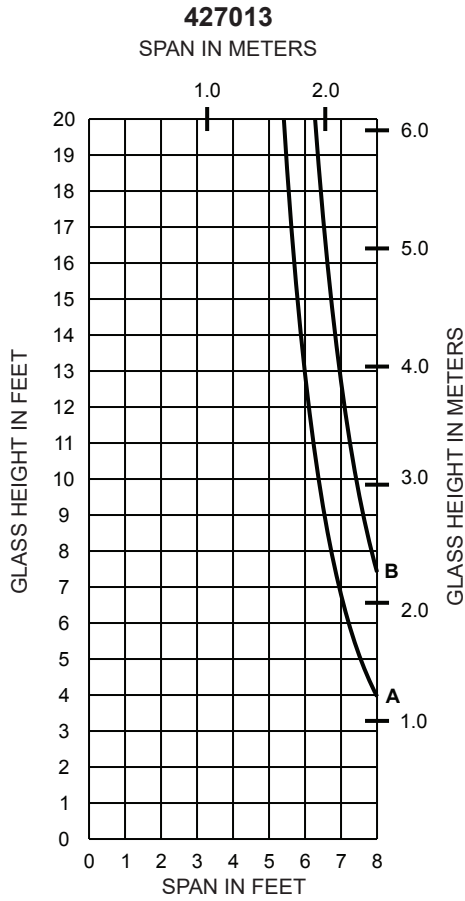

427013

I = 1.967 (81.87 x 10⁴)
 S = 1.515 (24.83 x 10³)

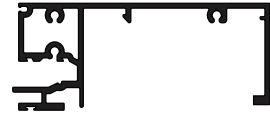
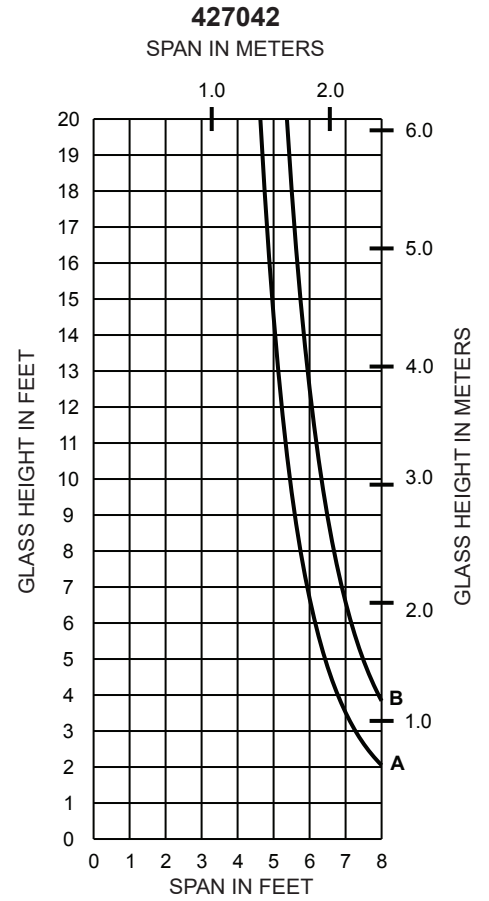

427042

I = 1.018 (42.37 x 10⁴)
 S = 0.728 (11.93 x 10³)

Laws and building and safety codes governing the design and use of Kawneer products, such as glazed entrance, window, and curtain wall products, vary widely. Kawneer does not control the selection of product configurations, operating hardware, or glazing materials, and assumes no responsibility therefor.

Kawneer reserves the right to change configuration without prior notice when deemed necessary for product improvement.
 © 2015, Kawneer Company, Inc.

A = 1-3/4" GLASS (1/4 POINT LOADING)
 B = 1-3/4" GLASS (1/8 POINT LOADING)

----- Horizontal framing above the dashed curve requires glass chair and setting blocks to be doubled up, due to maximum 125 lb. Glass weight limit per glass chair.

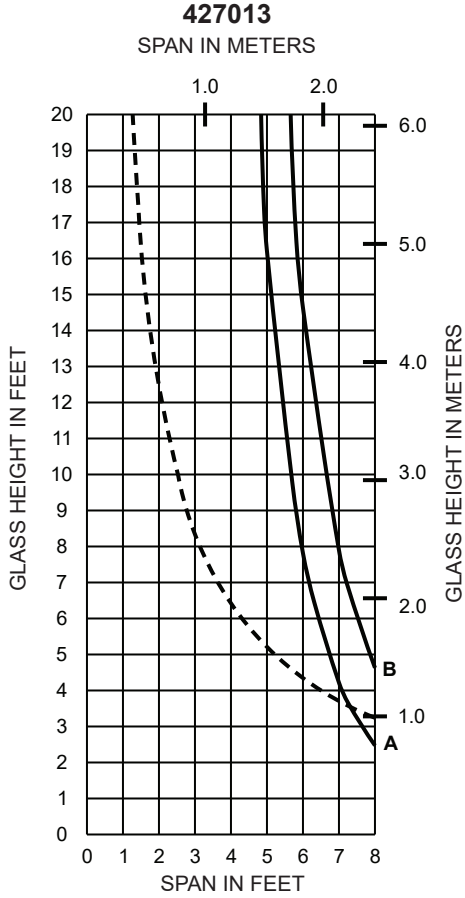

427013

I = 1.967 (81.87 x 10⁴)
 S = 1.515 (24.83 x 10³)

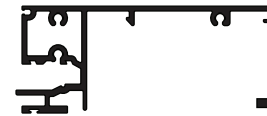
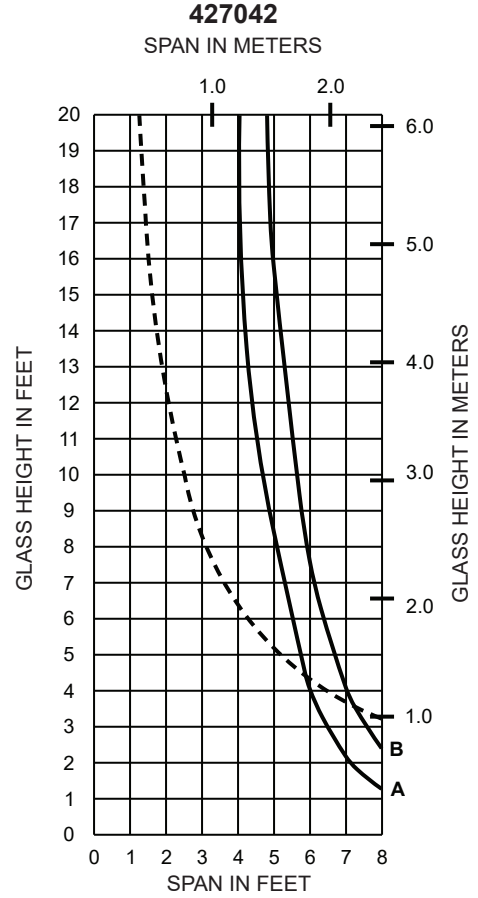

427042

I = 1.018 (42.37 x 10⁴)
 S = 0.728 (11.93 x 10³)

Laws and building and safety codes governing the design and use of Kawneer products, such as glazed entrance, window, and curtain wall products, vary widely. Kawneer does not control the selection of product configurations, operating hardware, or glazing materials, and assumes no responsibility therefor.

Kawneer reserves the right to change configuration without prior notice when deemed necessary for product improvement.

© 2015, Kawneer Company, Inc.

Generic Project Specific U-factor Example Calculation
(Percent of Glass will vary on specific products depending on sitelines)
(Based on single bay of Curtain Wall/Window Wall)

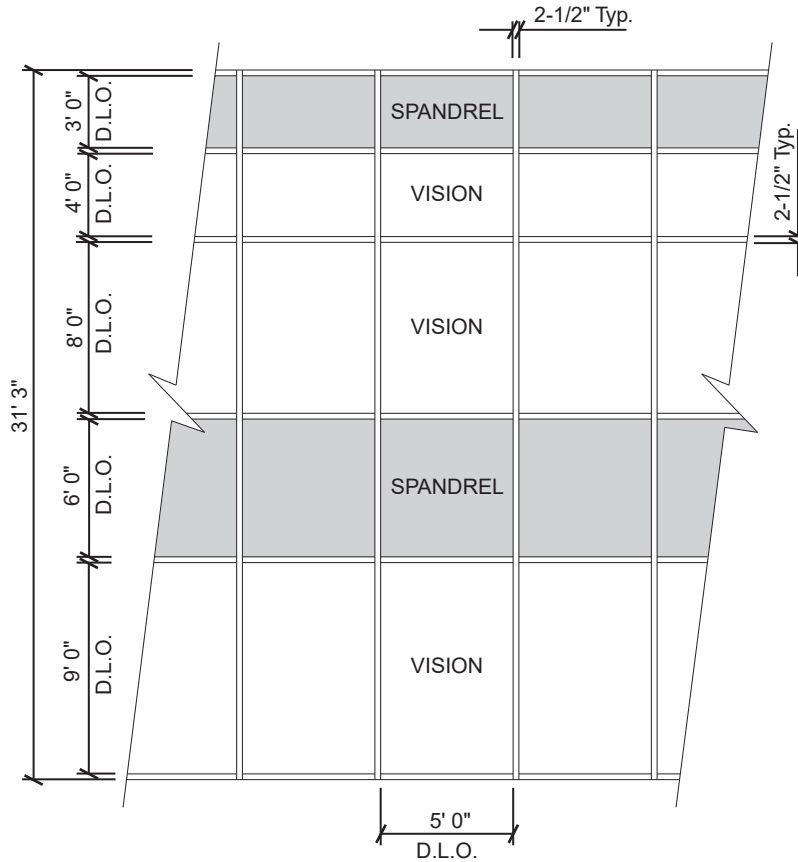

Vision Area

Example Glass U-factor = 0.42 Btu/(ft² · h · °F)

Vision Area = 5(9 + 8 + 4) = 105.0 ft²

Total Area (Vision) = 5' 2-1/2" (9' 3-3/4" + 8' 2-1/2" + 4' 2-1/2") = 113.2 ft²

Percentage of Vision Glass = (Vision Area ÷ Total Area)100
 = (105.0 ÷ 113.2)100 = 93%

Spandrel Area

Example Spandrel R-value = 15 (ft² · h · °F)/Btu

Spandrel Area = 5(6 + 3) = 45.0 ft²

Total Area (Spandrel) = 5' 2-1/2" (6' 2-1/2" + 3' 3-3/4") = 49.6 ft²

Percent of Spandrel = (Spandrel Area ÷ Total Area)100
 = (45.0 ÷ 49.6)100 = 91%

Laws and building and safety codes governing the design and use of Kawneer products, such as glazed entrance, window, and curtain wall products, vary widely. Kawneer does not control the selection of product configurations, operating hardware, or glazing materials, and assumes no responsibility therefor.

Kawneer reserves the right to change configuration without prior notice when deemed necessary for product improvement.
 © 2015, Kawneer Company, Inc.

Vision Area Chart

System U-factor vs Percent of Vision Area

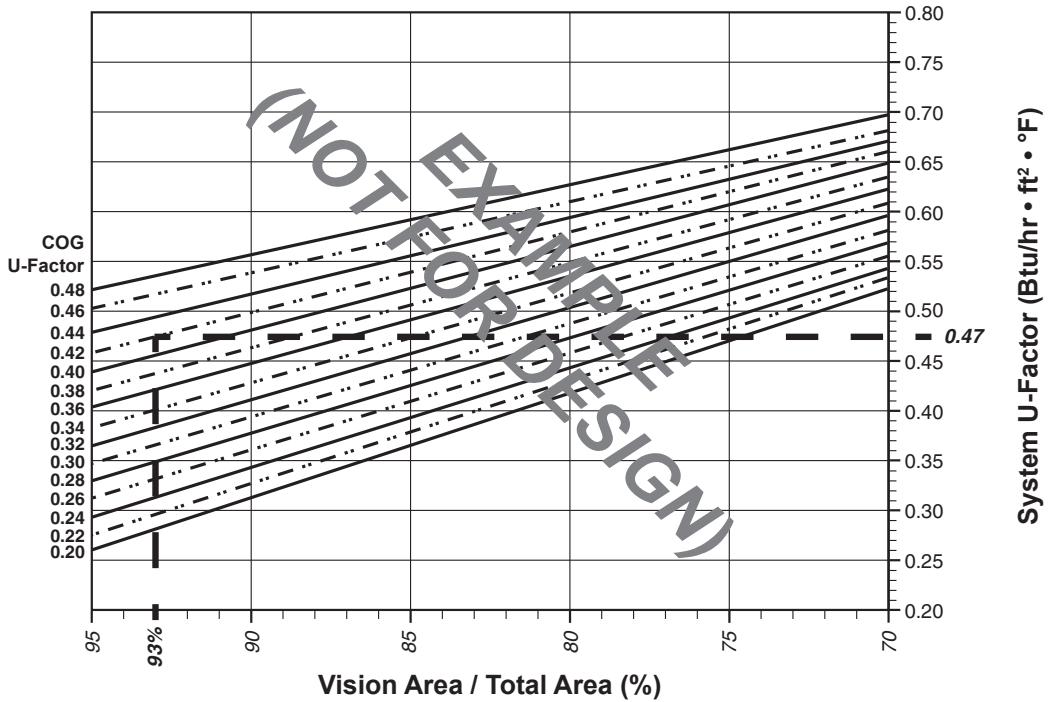

Based on 93% glass and center of glass U-Factor of 0.42
System U-Factor is equal to 0.47 Btu/hr • ft² • °F

Spandrel Area Chart

System U-factor vs Percent of Spandrel Area

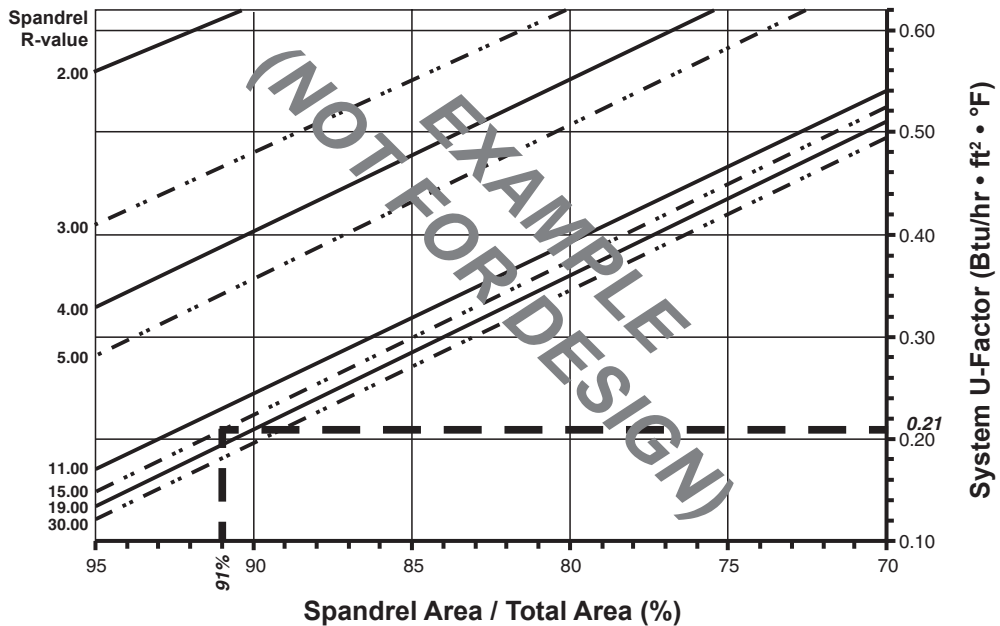

Based on 91% spandrel and center of spandrel R-value of 15,
system U-factor is equal to 0.21 Btu/hr • ft² • °F

Laws and building and safety codes governing the design and use of Kawneer products, such as glazed entrance, window, and curtain wall products, vary widely. Kawneer does not control the selection of product configurations, operating hardware, or glazing materials, and assumes no responsibility therefor.

Kawneer reserves the right to change configuration without prior notice when deemed necessary for product improvement.
© 2015, Kawneer Company, Inc.

CAPTURED SYSTEM
1" Double Glazed - Aluminum Glazing Spacer
System U-Factor vs Percent of Glass Area

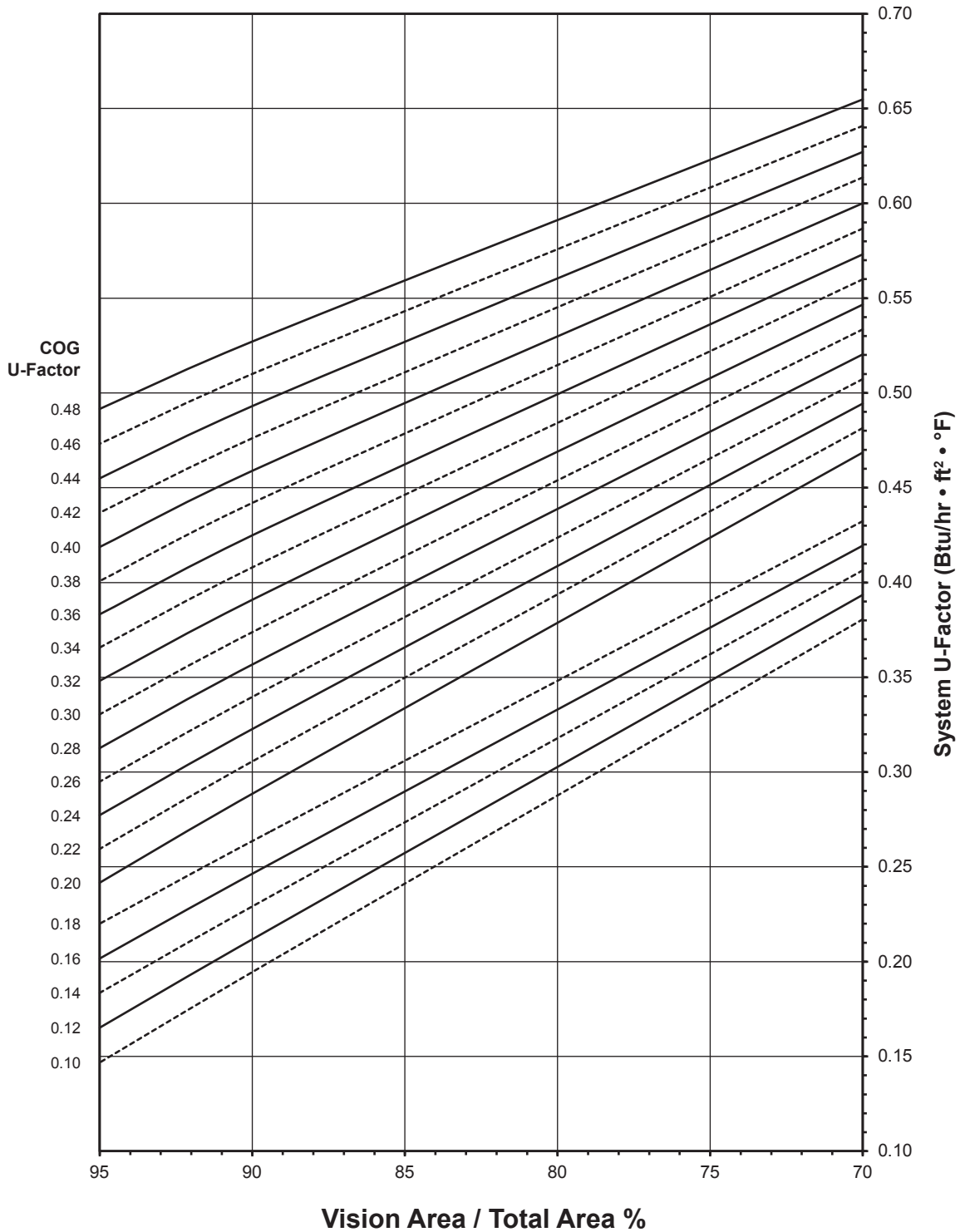

Notes for System U-Factor, SHGC and VT charts:
 For glass values that are not listed, linear interpolation is permitted.
 Glass properties are based on center of glass values and are obtained from your glass supplier.

Laws and building and safety codes governing the design and use of Kawneer products, such as glazed entrance, window, and curtain wall products, vary widely. Kawneer does not control the selection of product configurations, operating hardware, or glazing materials, and assumes no responsibility therefor.

Kawneer reserves the right to change configuration without prior notice when deemed necessary for product improvement.
 © 2015, Kawneer Company, Inc.

CAPTURED SYSTEM
1" Double Glazed - Aluminum Glazing Spacer

Note:

Values in parentheses are metric.
 COG = Center of Glass.
 Charts are generated per AAMA 507

System U-Factors for Spandrel Glass

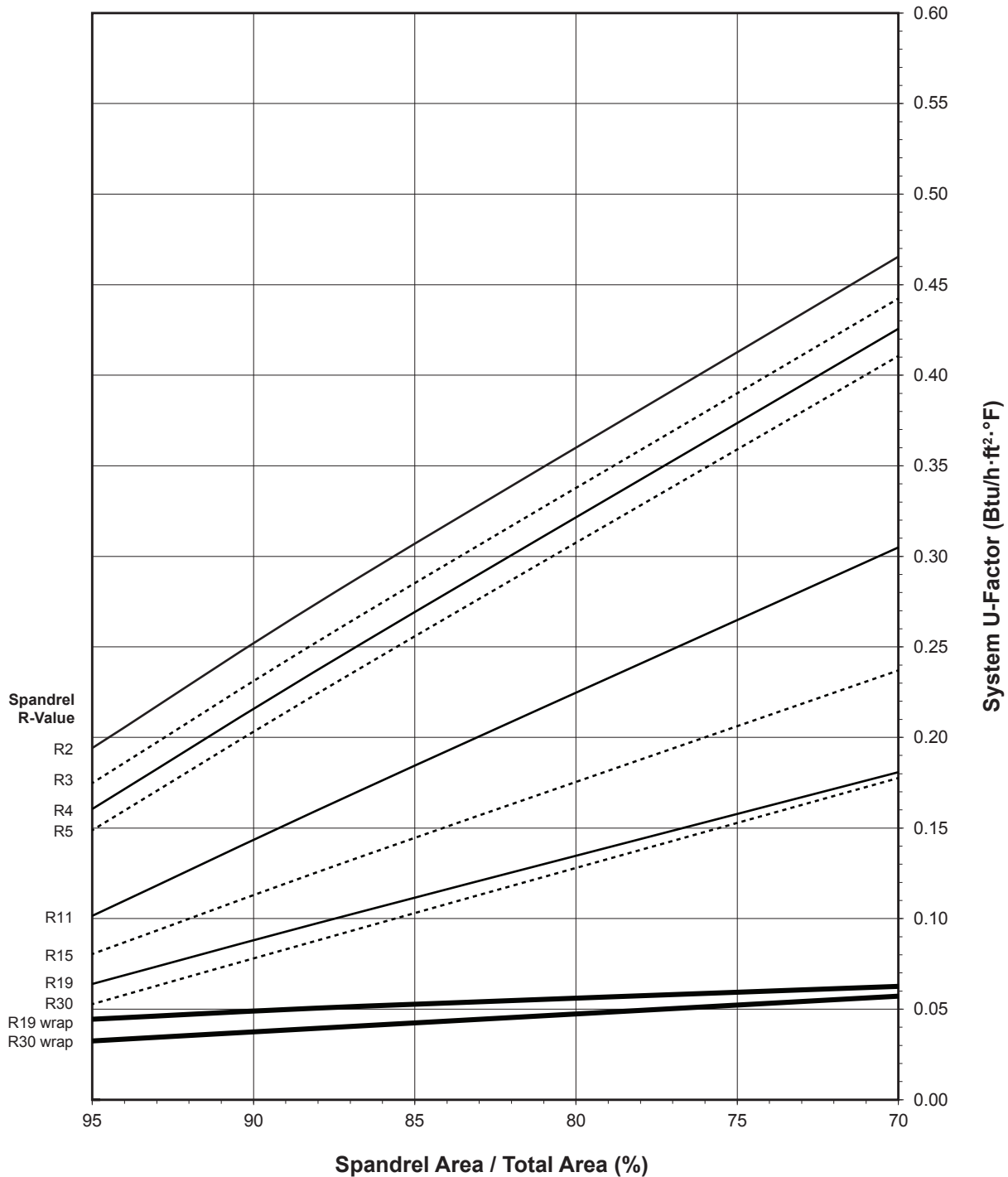

Laws and building and safety codes governing the design and use of Kawneer products, such as glazed entrance, window, and curtain wall products, vary widely. Kawneer does not control the selection of product configurations, operating hardware, or glazing materials, and assumes no responsibility therefor.

Kawneer reserves the right to change configuration without prior notice when deemed necessary for product improvement.

© 2015, Kawneer Company, Inc.

CAPTURED SYSTEM
1" Double Glazed - Aluminum Glazing Spacer

System Solar Heat Gain Coefficient (SHGC) vs Percent of Vision Area

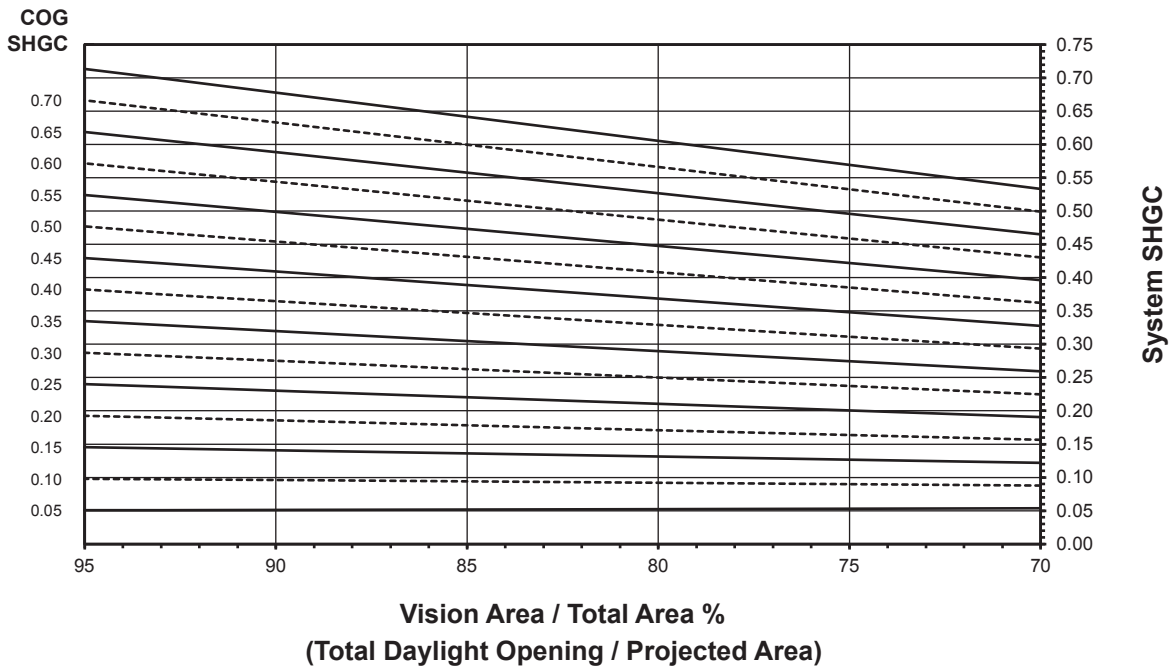

Charts are generated per AAMA 507

Visible Transmittance (VT) vs Percent of Vision Area

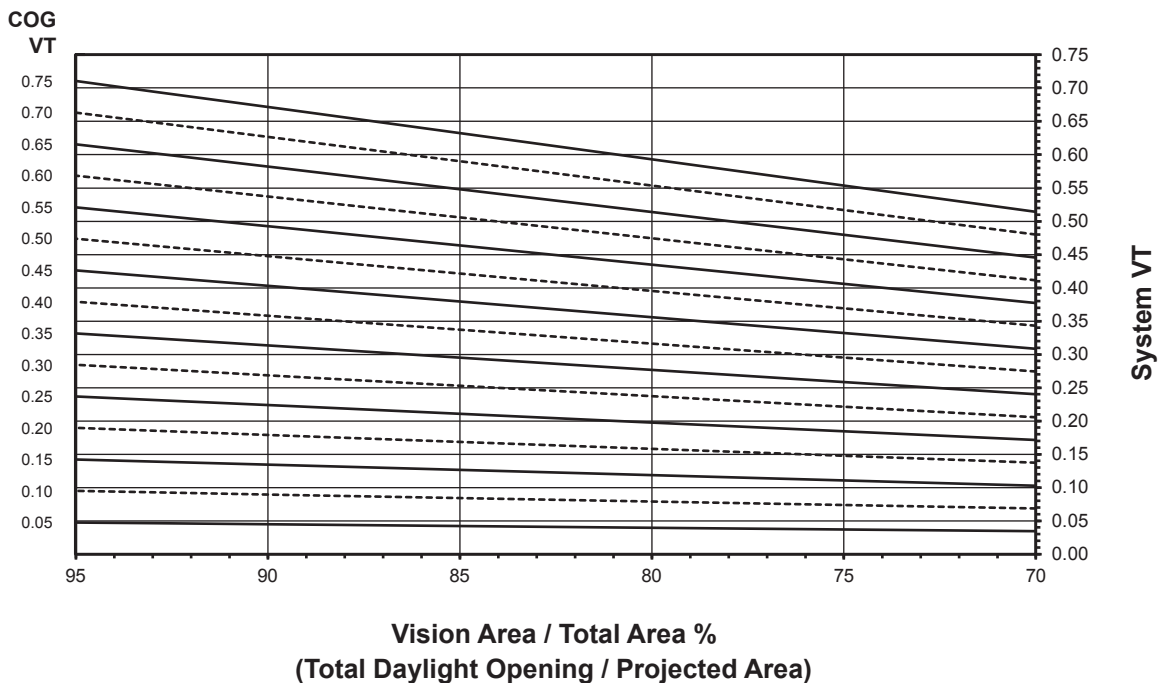

Laws and building and safety codes governing the design and use of Kawneer products, such as glazed entrance, window, and curtain wall products, vary widely. Kawneer does not control the selection of product configurations, operating hardware, or glazing materials, and assumes no responsibility therefor.

Kawneer reserves the right to change configuration without prior notice when deemed necessary for product improvement.
© 2015, Kawneer Company, Inc.

Thermal Transmittance¹ (BTU/hr • ft² • °F)

Glass U-Factor ³	Overall U-Factor ⁴
0.48	0.53
0.46	0.51
0.44	0.50
0.42	0.48
0.40	0.46
0.38	0.45
0.36	0.43
0.34	0.41
0.32	0.40
0.30	0.38
0.28	0.36
0.26	0.34
0.24	0.33
0.22	0.31
0.20	0.29
0.18	0.27
0.16	0.25
0.14	0.23
0.12	0.22
0.10	0.20

CAPTURED SYSTEM
1" Double Glazed
Aluminum Glazing Spacer

NOTE: For glass values that are not listed, linear interpolation is permitted.

1. U-Factors are determined in accordance with NFRC 100.
2. SHGC and VT values are determined in accordance with NFRC 200.
3. Glass properties are based on center of glass values and are obtained from your glass supplier.
4. Overall U-Factor, SHGC, and VT Matricies are based on the standard NFRC specimen size of 2,000 mm wide by 2,000 mm high (78-3/4" by 78-3/4").

SHGC Matrix²

Glass SHGC ³	Overall SHGC ⁴
0.75	0.67
0.70	0.63
0.65	0.58
0.60	0.54
0.55	0.50
0.50	0.45
0.45	0.41
0.40	0.36
0.35	0.32
0.30	0.27
0.25	0.23
0.20	0.18
0.15	0.14
0.10	0.10
0.05	0.05

Visible Transmittance²

Glass VT ³	Overall VT ⁴
0.75	0.67
0.70	0.62
0.65	0.58
0.60	0.53
0.55	0.49
0.50	0.44
0.45	0.40
0.40	0.36
0.35	0.31
0.30	0.27
0.25	0.22
0.20	0.18
0.15	0.13
0.10	0.09
0.05	0.04

Laws and building and safety codes governing the design and use of Kawneer products, such as glazed entrance, window, and curtain wall products, vary widely. Kawneer does not control the selection of product configurations, operating hardware, or glazing materials, and assumes no responsibility therefor.

Kawneer reserves the right to change configuration without prior notice when deemed necessary for product improvement.
© 2015, Kawneer Company, Inc.

4-SIDED SSG SYSTEM
1" Double Glazed - Aluminum Glazing Spacer
System U-Factor vs Percent of Glass Area

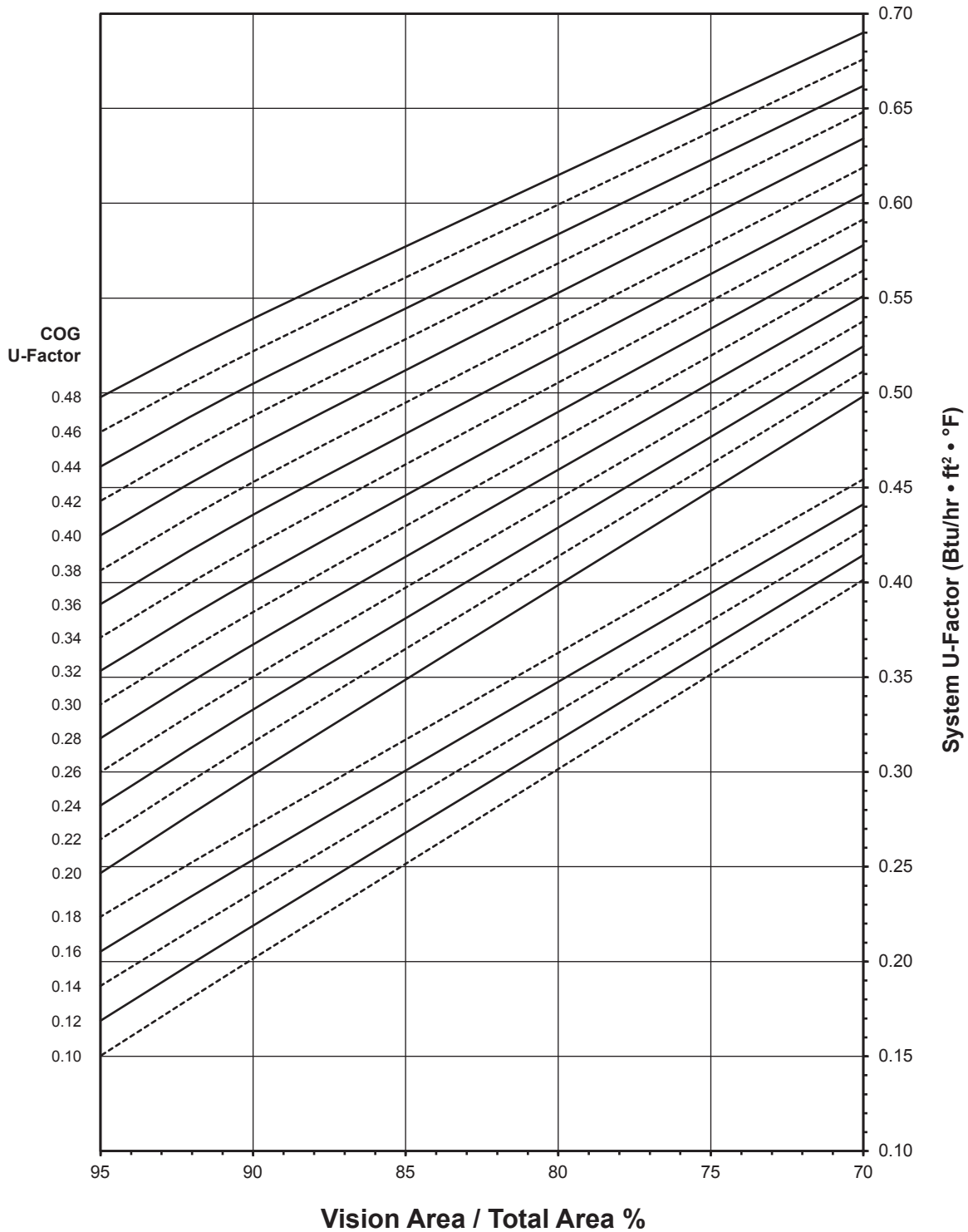

Notes for System U-Factor, SHGC and VT charts:
 For glass values that are not listed, linear interpolation is permitted.
 Glass properties are based on center of glass values and are obtained from your glass supplier.

Laws and building and safety codes governing the design and use of Kawneer products, such as glazed entrance, window, and curtain wall products, vary widely. Kawneer does not control the selection of product configurations, operating hardware, or glazing materials, and assumes no responsibility therefor.

Kawneer reserves the right to change configuration without prior notice when deemed necessary for product improvement.
 © 2015, Kawneer Company, Inc.

4-SIDED SSG SYSTEM
1" Double Glazed - Aluminum Glazing Spacer

System Solar Heat Gain Coefficient (SHGC) vs Percent of Vision Area

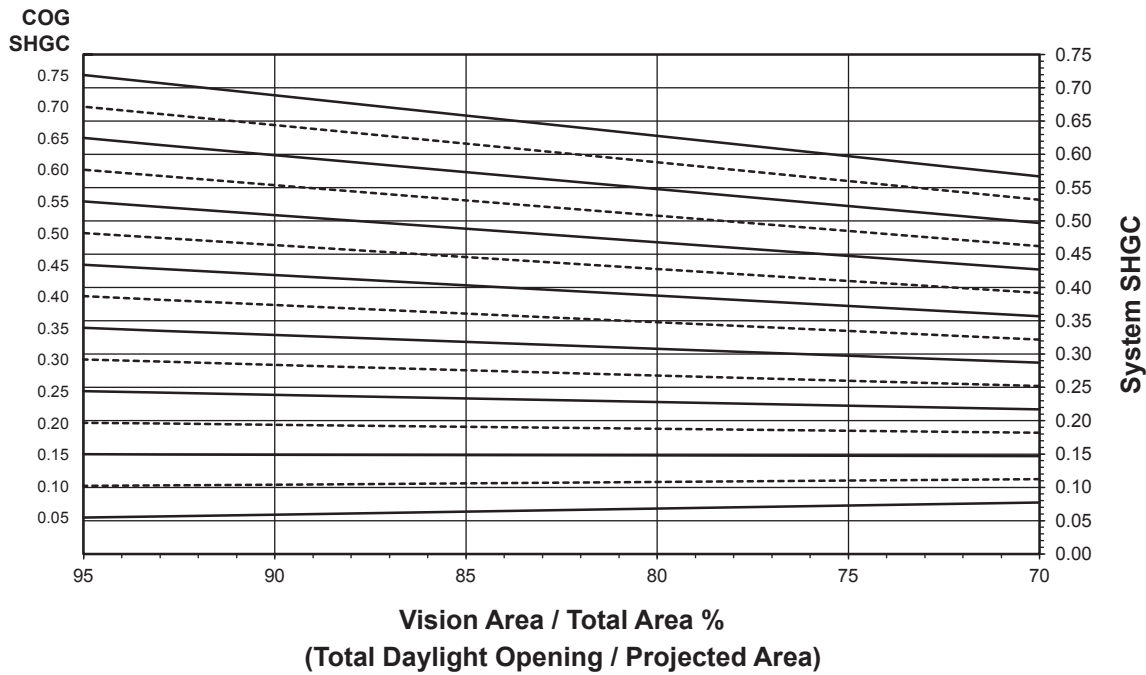

Charts are generated per AAMA 507

Visible Transmittance (VT) vs Percent of Vision Area

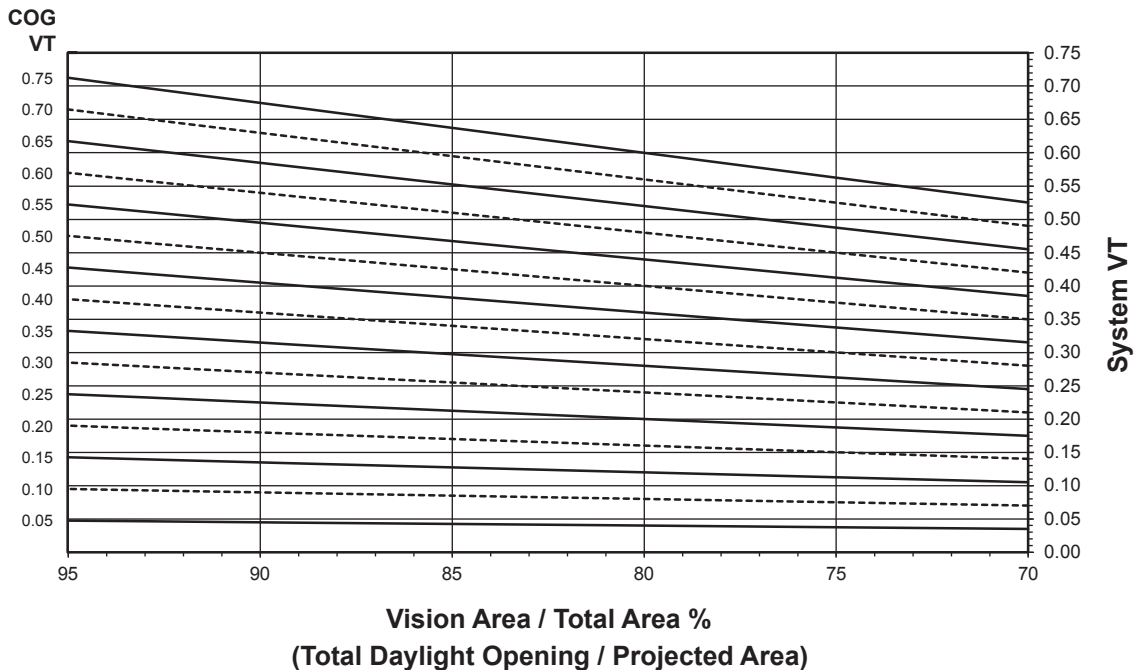

Laws and building and safety codes governing the design and use of Kawneer products, such as glazed entrance, window, and curtain wall products, vary widely. Kawneer does not control the selection of product configurations, operating hardware, or glazing materials, and assumes no responsibility therefor.

Kawneer reserves the right to change configuration without prior notice when deemed necessary for product improvement.
 © 2015, Kawneer Company, Inc.

Thermal Transmittance ¹ (BTU/hr • ft ² • °F)

Glass U-Factor ³	Overall U-Factor ⁴
0.48	0.54
0.46	0.53
0.44	0.51
0.42	0.49
0.40	0.48
0.38	0.46
0.36	0.44
0.34	0.42
0.32	0.41
0.30	0.39
0.28	0.37
0.26	0.36
0.24	0.34
0.22	0.32
0.20	0.30
0.18	0.28
0.16	0.26
0.14	0.24
0.12	0.22
0.10	0.21

**4-SIDED SSG SYSTEM
1" Double Glazed
Aluminum Glazing Spacer**

NOTE: For glass values that are not listed, linear interpolation is permitted.

1. U-Factors are determined in accordance with NFRC 100.
2. SHGC and VT values are determined in accordance with NFRC 200.
3. Glass properties are based on center of glass values and are obtained from your glass supplier.
4. Overall U-Factor, SHGC, and VT Matrices are based on the standard NFRC specimen size of 2,000 mm wide by 2,000 mm high (78-3/4" by 78-3/4").

SHGC Matrix ²

Glass SHGC ³	Overall SHGC ⁴
0.75	0.69
0.70	0.64
0.65	0.60
0.60	0.55
0.55	0.51
0.50	0.46
0.45	0.42
0.40	0.37
0.35	0.33
0.30	0.28
0.25	0.24
0.20	0.19
0.15	0.15
0.10	0.10
0.05	0.06

Visible Transmittance ²

Glass VT ³	Overall VT ⁴
0.75	0.67
0.70	0.63
0.65	0.58
0.60	0.54
0.55	0.49
0.50	0.45
0.45	0.40
0.40	0.36
0.35	0.31
0.30	0.27
0.25	0.22
0.20	0.18
0.15	0.13
0.10	0.09
0.05	0.04

Laws and building and safety codes governing the design and use of Kawneer products, such as glazed entrance, window, and curtain wall products, vary widely. Kawneer does not control the selection of product configurations, operating hardware, or glazing materials, and assumes no responsibility therefor.

Kawneer reserves the right to change configuration without prior notice when deemed necessary for product improvement.
© 2015, Kawneer Company, Inc.

CAPTURED SYSTEM
1-3/4" Triple Glazed - Warm-Edge Glazing Spacer
System U-Factor vs Percent of Glass Area

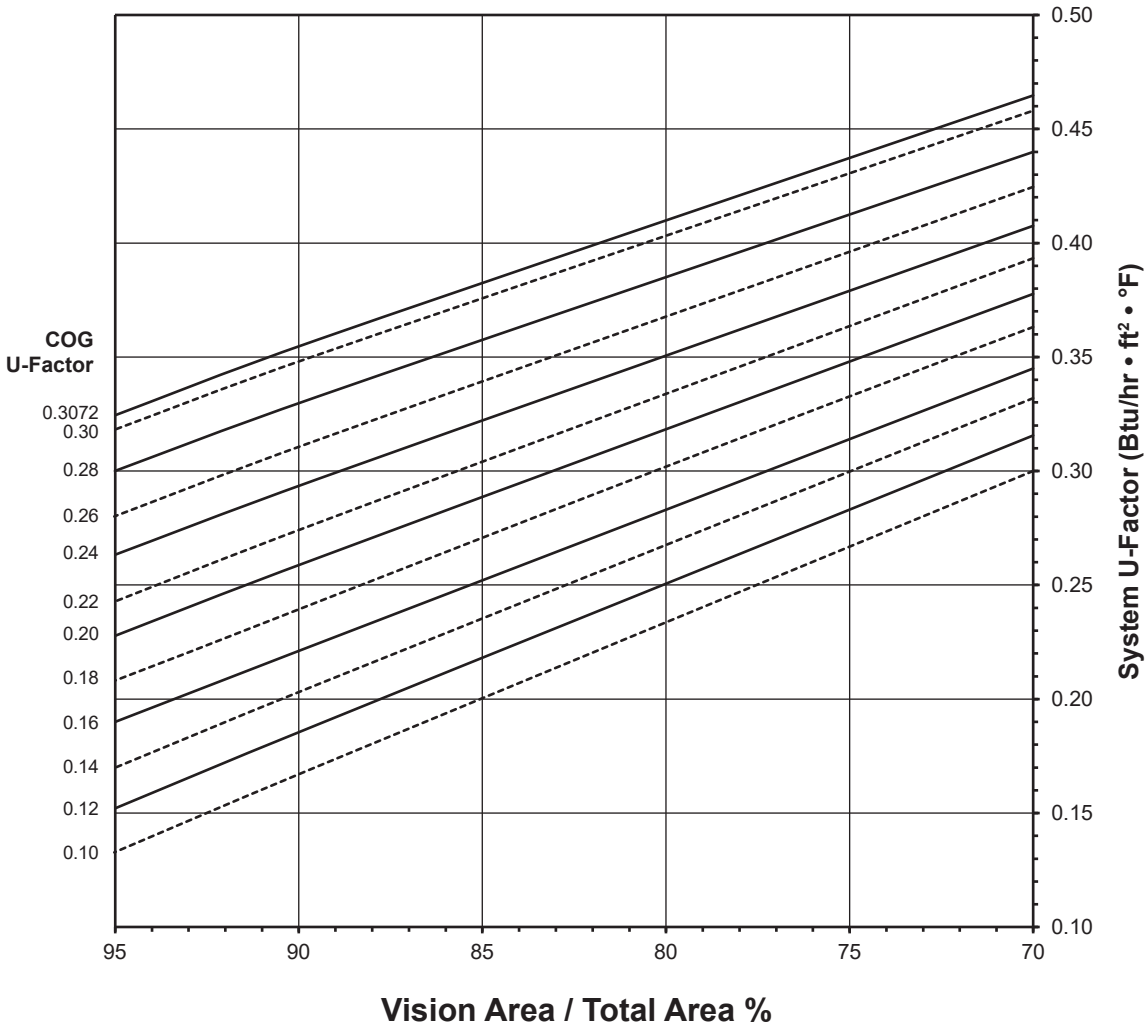

Notes for System U-Factor, SHGC and VT charts:

For glass values that are not listed, linear interpolation is permitted.

Glass properties are based on center of glass values and are obtained from your glass supplier.

Laws and building and safety codes governing the design and use of Kawneer products, such as glazed entrance, window, and curtain wall products, vary widely. Kawneer does not control the selection of product configurations, operating hardware, or glazing materials, and assumes no responsibility therefor.

Kawneer reserves the right to change configuration without prior notice when deemed necessary for product improvement.
 © 2015, Kawneer Company, Inc.

CAPTURED SYSTEM
1-3/4" Triple Glazed - Warm-Edge Glazing Spacer

System Solar Heat Gain Coefficient (SHGC) vs Percent of Vision Area

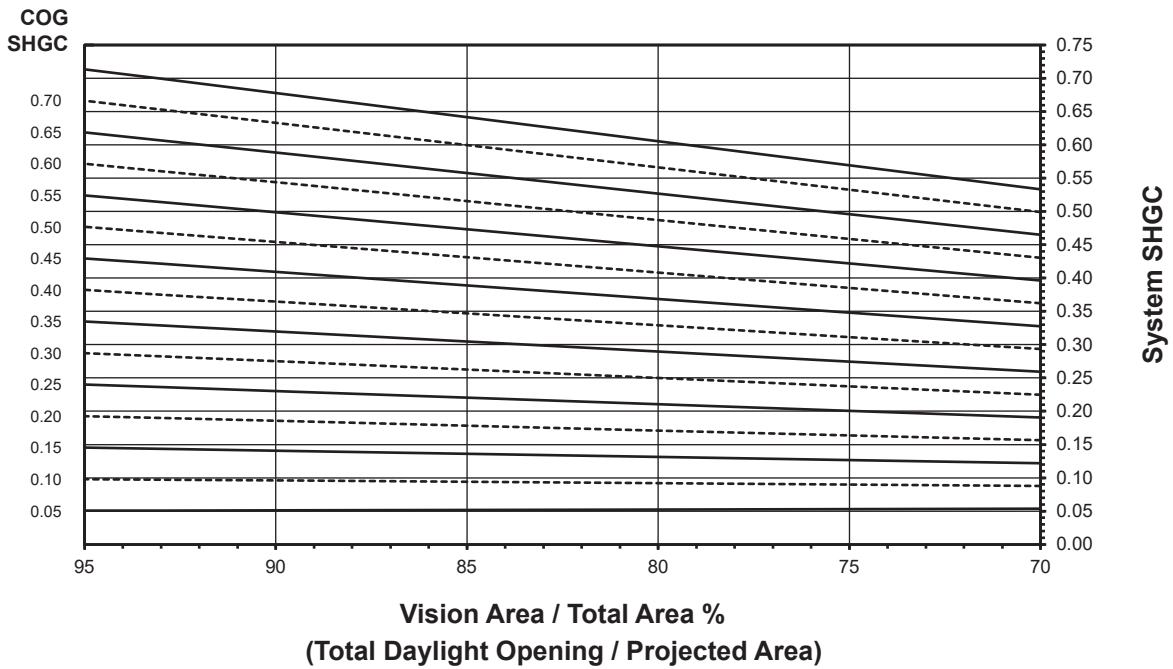

Charts are generated per AAMA 507

Visible Transmittance (VT) vs Percent of Vision Area

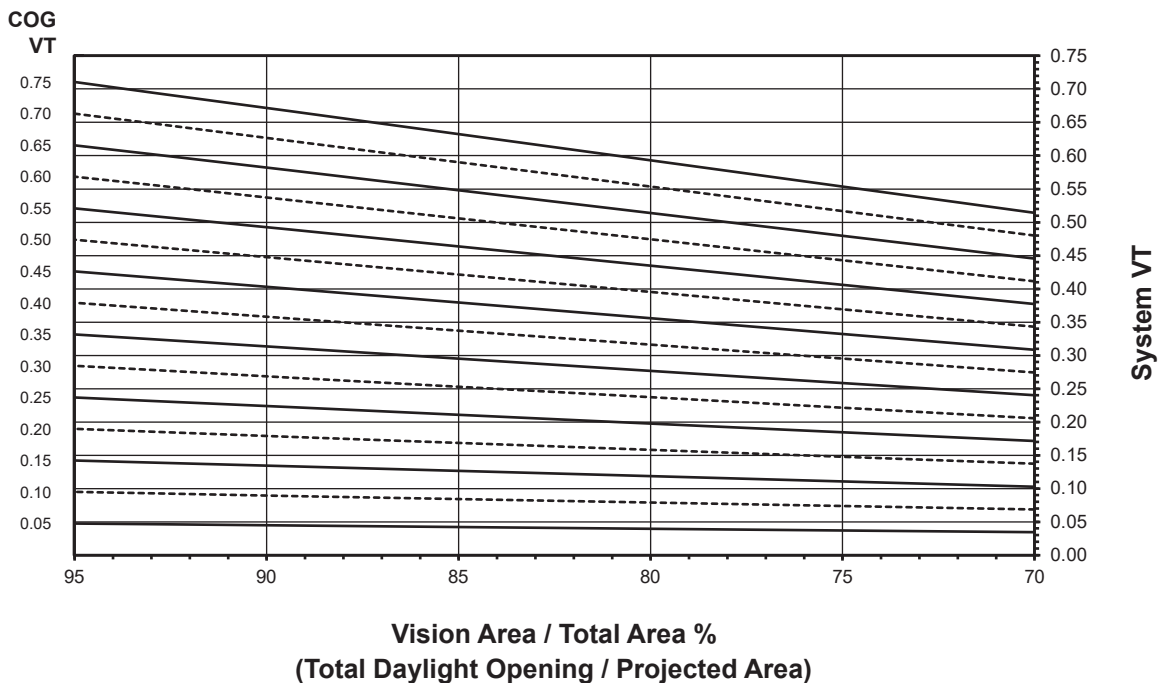

Laws and building and safety codes governing the design and use of Kawneer products, such as glazed entrance, window, and curtain wall products, vary widely. Kawneer does not control the selection of product configurations, operating hardware, or glazing materials, and assumes no responsibility therefor.

Kawneer reserves the right to change configuration without prior notice when deemed necessary for product improvement.
© 2015, Kawneer Company, Inc.

Thermal Transmittance¹ (BTU/hr • ft² • °F)

Glass U-Factor ³	Overall U-Factor ⁴
0.31	0.36
0.30	0.35
0.28	0.33
0.26	0.31
0.24	0.30
0.22	0.28
0.20	0.26
0.18	0.24
0.16	0.22
0.14	0.21
0.12	0.19
0.10	0.17

CAPTURED SYSTEM
1-3/4" Triple Glazed
Warm-Edge Glazing Spacer

NOTE: For glass values that are not listed, linear interpolation is permitted.

1. U-Factors are determined in accordance with NFRC 100.
2. SHGC and VT values are determined in accordance with NFRC 200.
3. Glass properties are based on center of glass values and are obtained from your glass supplier.
4. Overall U-Factor, SHGC, and VT Matricies are based on the standard NFRC specimen size of 2,000 mm wide by 2,000 mm high (78-3/4" by 78-3/4").

SHGC Matrix²

Glass SHGC ³	Overall SHGC ⁴
0.75	0.67
0.70	0.63
0.65	0.58
0.60	0.54
0.55	0.50
0.50	0.45
0.45	0.41
0.40	0.36
0.35	0.32
0.30	0.27
0.25	0.23
0.20	0.18
0.15	0.14
0.10	0.10
0.05	0.05

Visible Transmittance²

Glass VT ³	Overall VT ⁴
0.75	0.67
0.70	0.62
0.65	0.58
0.60	0.53
0.55	0.49
0.50	0.44
0.45	0.40
0.40	0.36
0.35	0.31
0.30	0.27
0.25	0.22
0.20	0.18
0.15	0.13
0.10	0.09
0.05	0.04

Laws and building and safety codes governing the design and use of Kawneer products, such as glazed entrance, window, and curtain wall products, vary widely. Kawneer does not control the selection of product configurations, operating hardware, or glazing materials, and assumes no responsibility therefor.

Kawneer reserves the right to change configuration without prior notice when deemed necessary for product improvement.
© 2015, Kawneer Company, Inc.

4-SIDED SSG SYSTEM
1-3/4" Triple Glazed - Warm-Edge Glazing Spacer
System U-Factor vs Percent of Glass Area

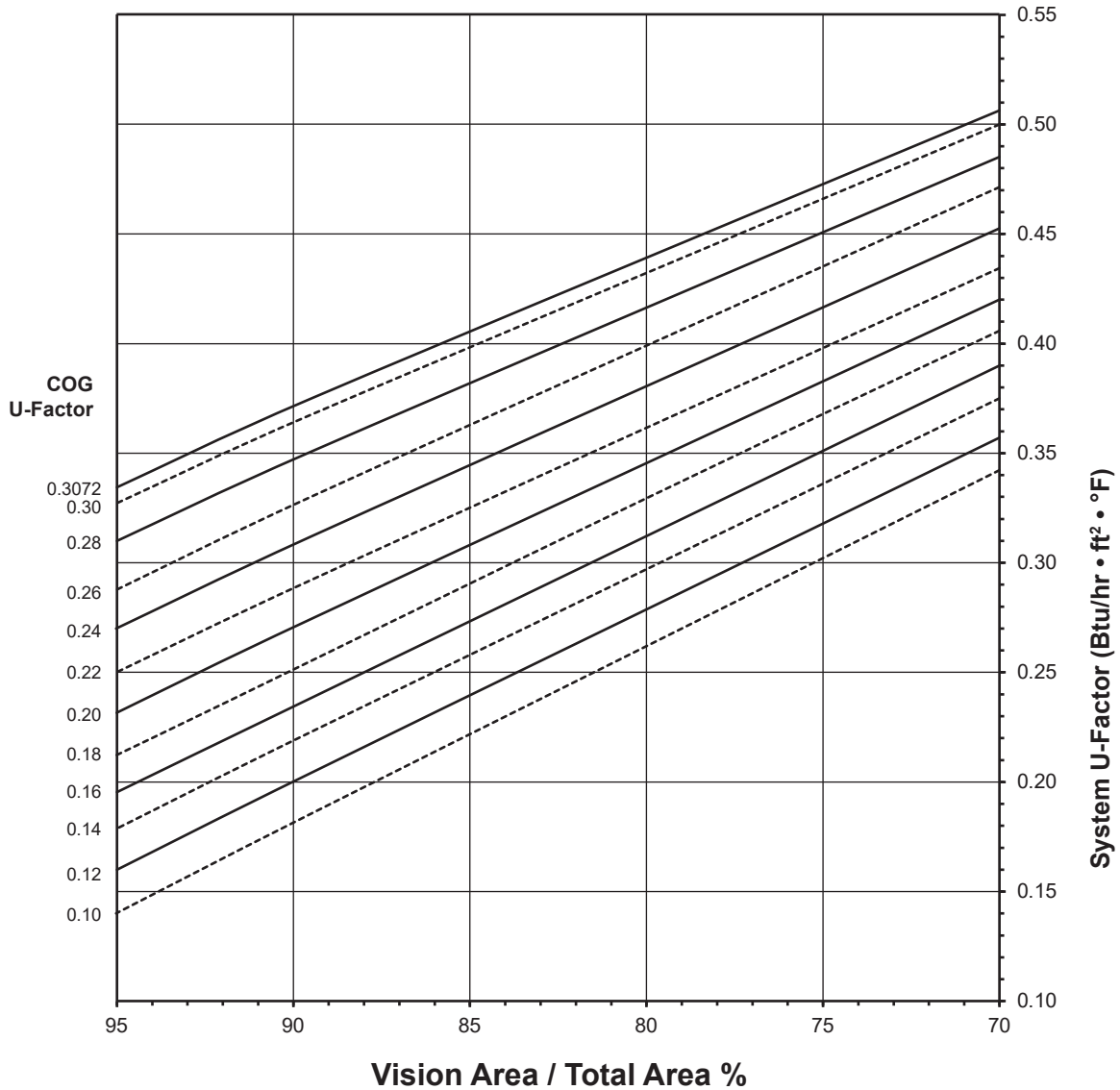

Notes for System U-Factor, SHGC and VT charts:

For glass values that are not listed, linear interpolation is permitted.

Glass properties are based on center of glass values and are obtained from your glass supplier.

Laws and building and safety codes governing the design and use of Kawneer products, such as glazed entrance, window, and curtain wall products, vary widely. Kawneer does not control the selection of product configurations, operating hardware, or glazing materials, and assumes no responsibility therefor.

Kawneer reserves the right to change configuration without prior notice when deemed necessary for product improvement.
 © 2015, Kawneer Company, Inc.

4-SIDED SSG SYSTEM
1-3/4" Triple Glazed - Warm-Edge Glazing Spacer

System Solar Heat Gain Coefficient (SHGC) vs Percent of Vision Area

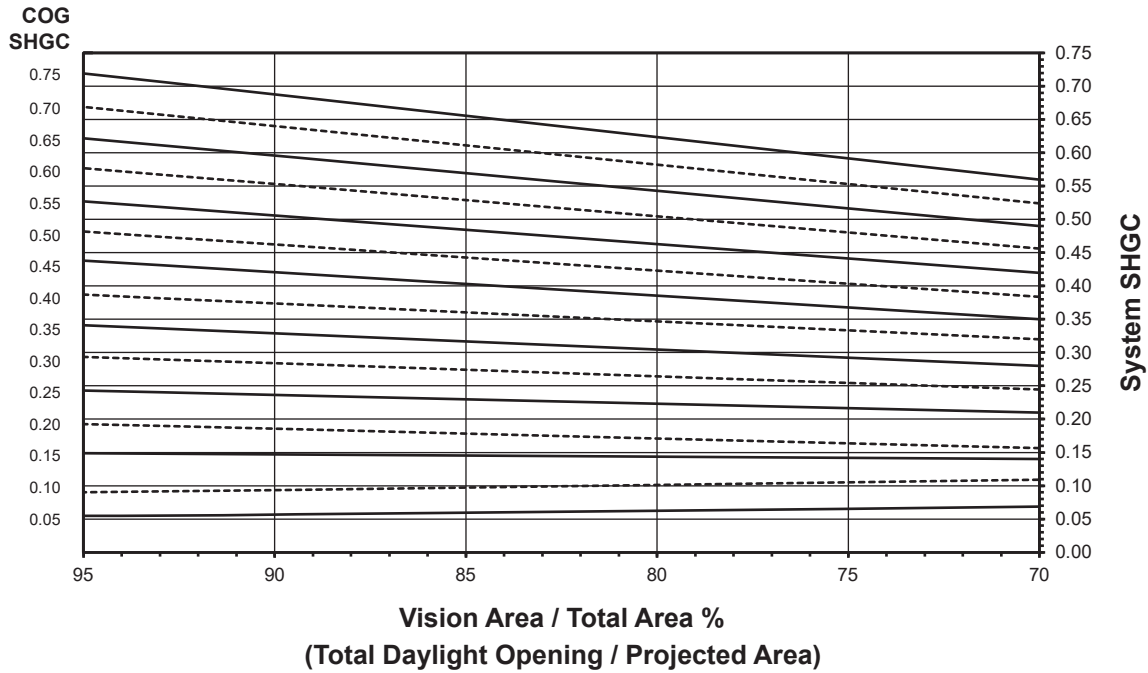

Charts are generated per AAMA 507

Visible Transmittance (VT) vs Percent of Vision Area

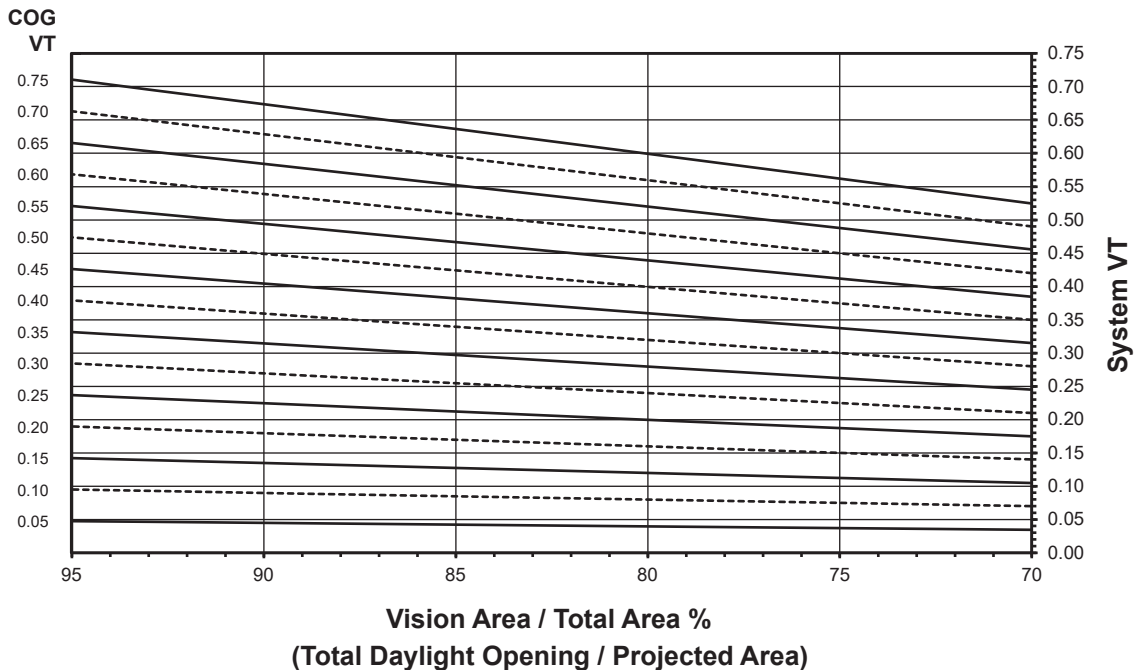

Laws and building and safety codes governing the design and use of Kawneer products, such as glazed entrance, window, and curtain wall products, vary widely. Kawneer does not control the selection of product configurations, operating hardware, or glazing materials, and assumes no responsibility therefor.

Kawneer reserves the right to change configuration without prior notice when deemed necessary for product improvement.
 © 2015, Kawneer Company, Inc.

Thermal Transmittance ¹ (BTU/hr • ft ² • °F)

Glass U-Factor ³	Overall U-Factor ⁴
0.31	0.37
0.30	0.37
0.28	0.35
0.26	0.33
0.24	0.31
0.22	0.29
0.20	0.27
0.18	0.26
0.16	0.24
0.14	0.22
0.12	0.20
0.10	0.18

**4-SIDED SSG SYSTEM
1-3/4" Triple Glazed
Warm-Edge Glazing Spacer**

NOTE: For glass values that are not listed, linear interpolation is permitted.

1. U-Factors are determined in accordance with NFRC 100.
2. SHGC and VT values are determined in accordance with NFRC 200.
3. Glass properties are based on center of glass values and are obtained from your glass supplier.
4. Overall U-Factor, SHGC, and VT Matricies are based on the standard NFRC specimen size of 2,000 mm wide by 2,000 mm high (78-3/4" by 78-3/4").

SHGC Matrix ²

Glass SHGC ³	Overall SHGC ⁴
0.75	0.68
0.70	0.64
0.65	0.59
0.60	0.55
0.55	0.50
0.50	0.46
0.45	0.42
0.40	0.37
0.35	0.33
0.30	0.28
0.25	0.24
0.20	0.19
0.15	0.15
0.10	0.10
0.05	0.06

Visible Transmittance ²

Glass VT ³	Overall VT ⁴
0.75	0.67
0.70	0.63
0.65	0.58
0.60	0.54
0.55	0.49
0.50	0.45
0.45	0.40
0.40	0.36
0.35	0.31
0.30	0.27
0.25	0.22
0.20	0.18
0.15	0.13
0.10	0.09
0.05	0.04

Laws and building and safety codes governing the design and use of Kawneer products, such as glazed entrance, window, and curtain wall products, vary widely. Kawneer does not control the selection of product configurations, operating hardware, or glazing materials, and assumes no responsibility therefor.

Kawneer reserves the right to change configuration without prior notice when deemed necessary for product improvement.
© 2015, Kawneer Company, Inc.

CONDENSATION RESISTANCE

Glazing Infill	Condensation Resistance Factor (CRF) AAMA 1503		Temperature Index (TI) CSA A440-0	
	Frame	Glass	Frame	Glass
1" Double Captured	80	72	69	65
1" Double 4-Sided SSG	80	71	75	65
1-3/4" Triple Captured	81	72	65	65
1-3/4" Triple 4-Sided SSG	85	77	79	72

Laws and building and safety codes governing the design and use of Kawneer products, such as glazed entrance, window, and curtain wall products, vary widely. Kawneer does not control the selection of product configurations, operating hardware, or glazing materials, and assumes no responsibility therefor.

Kawneer reserves the right to change configuration without prior notice when deemed necessary for product improvement.
© 2015, Kawneer Company, Inc.